

Wireless World

September 1968 Three Shillings

Constructing i. c. pattern generator

Follow that voltage

Tape-recorder supplement



JOHN F. KENNEDY SPACE CENTER
NASA LIBRARY

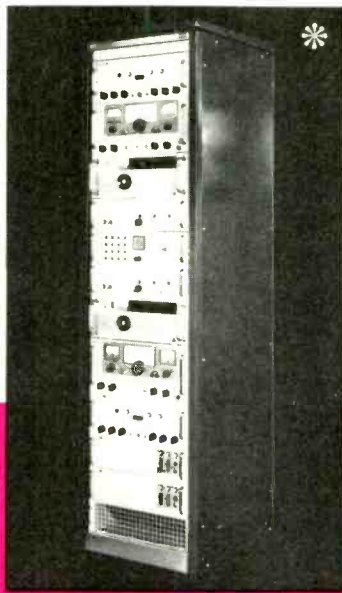

Single Path or Dual Diversity
Receiver Equipment RXII Series

High grade fully transistorised receiver equipment operating in the frequency band 2-4-30MHz. Available for a wide variety of applications, and reception of the following emissions: A1, A2, A3, A3a, A3b, A3h, A4, A7a, A7b, A9b, F1, F4 and F6.

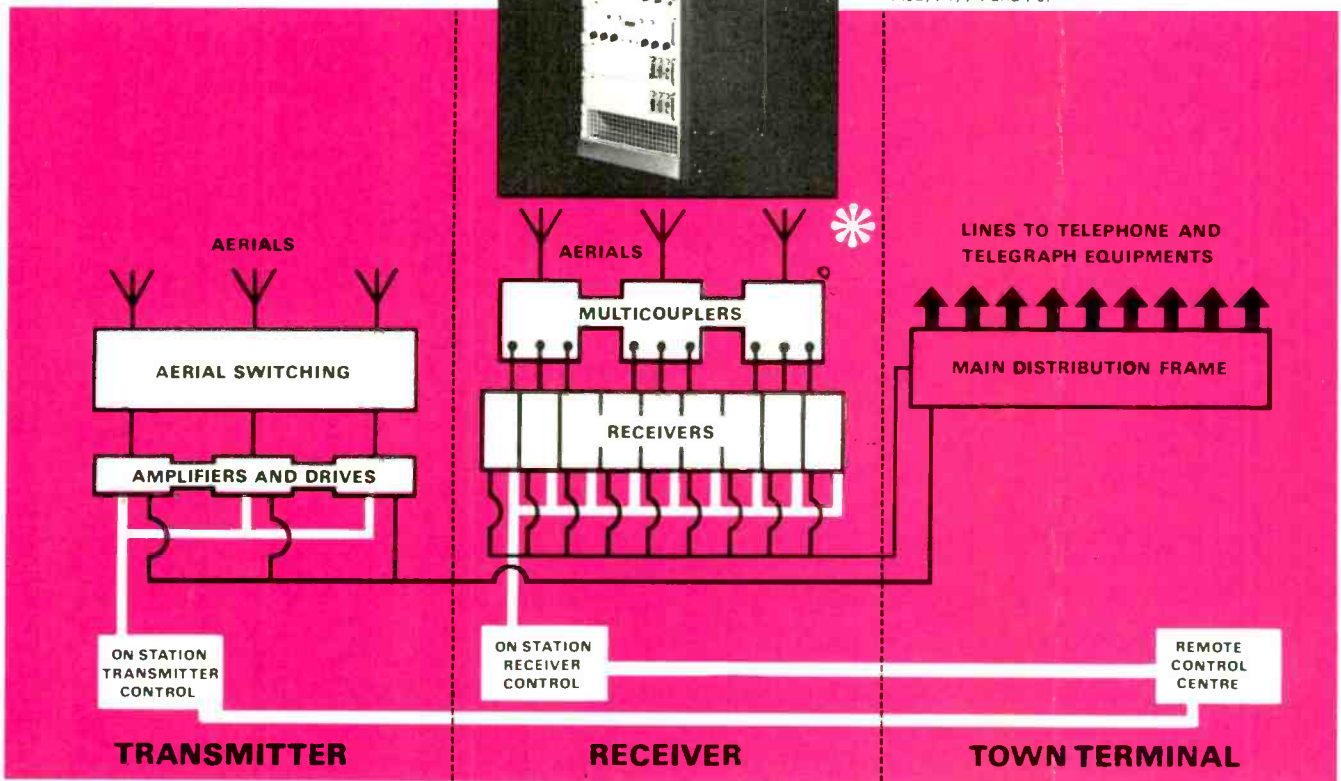

Cut the operational and maintenance costs of your H.F. radio station right now with STANFAST

Here's how

STANFAST Systems — the STC concept of automated h.f. radio stations—permit transmitting and receiving installations to be controlled completely by one man from a central location.

STANFAST Systems provide high speed frequency changing, automatic performance monitoring and rapid fault location, affording optimum traffic handling capability and maximum revenue.

STANFAST Systems use the latest techniques in radio design, demand smaller sites and require less maintenance than hitherto. Initial capital cost is lower and return on investment is greater.

Standard Telephones and Cables Limited, Radio Division, Oakleigh Road, New Southgate, London N.11. Telephone: 01-368 1200. Telex: 261912.

world-wide telecommunications and electronics

STC

Wireless World

Electronics, Television, Radio, Audio

Fifty-eighth year of publication

September 1968

Volume 74 Number 1395

Contents

- 289 Editorial Comment
- 290 *Wireless World* Crosshatch and Dot Generator
- 295 Voltage Following by *P. Williams*
- 298 Position-sensitive Particle Detector
- 299 International Ships' Gear Exhibition
- 300 The Fuel Cell by *G. Beardmore*
- 302 Conferences and Exhibitions
- 303 Letters to the Editor
- 305 Letter from America
- 306 News of the Month
S.R.C. Review
Russian Colour Sets in London
Giant Radio Astronomy Satellite
- 309 Personalities
- 310 Constant-voltage D.C. Supplies by *T. D. Towers*
- 315 Announcements
- 316 Low-cost High-quality Loudspeaker—2 by *P. J. Baxandall*
- 319 Imagination Intensifier for the Visible Spectrum
- 320 Test Your Knowledge questions & answers by *L. Ibbotson*
- 321 *Wireless World* Colour Television Receiver—4
- 324 Literature Received
- 324 H.F. Predictions
- 325 Demonstrating Radar Using Sonar—2 by *B. A. Wyndham*
- 328 Anti-collision Radar Aid
- 329 Combating Television Interference
- 330 New Products
- 334 World of Amateur Radio
- 336 Real & Imaginary by "Vector"
TAPE RECORDER SUPPLEMENT
Tape Recording Practice by *R. L. West*
Recent Products



This month's cover features the pattern generator described in this issue, superimposed on the cross-hatch pattern produced on the *Wireless World* colour receiver before convergence adjustments commenced.

Hiffe Technical Publications Ltd.,
Managing Director: Kenneth Tett
Editorial Director: George H. Mansell
Advertisement Director: George Fowkes
Dorset House, Stamford Street, London, SE1

© Hiffe Technical Publications Ltd., 1968
Permission in writing from the Editor must first be obtained before letterpress or illustrations are reproduced from this journal. Brief extracts or comments are allowed provided acknowledgement to the journal is given.

PUBLISHED MONTHLY (3rd Monday of preceding month). Telephone: 01-928 3333 (70 lines). Telegrams/Telex: Wiworld Hiffepres 25137 London. Cables: "Ethaworld, London, S.E.1." Annual Subscriptions: Home; £2 6s 0d. Overseas; 1 year £2 15s 0d. Canada and U.S.A.; \$6.75; 3 years £7 0s 0d. Canada and U.S.A.; \$17.50 Second-Class mail privileges authorised at New York N.Y. Subscribers are requested to notify a change of address four weeks in advance and to return wrapper bearing previous address. BRANCH OFFICES: BIRMINGHAM: 401, Lynton House, Walsall Road, 22b. Telephone: 021-356 4838. BRISTOL: 11 Marsh Street, 1. Telephone: 0272 21491/2. COVENTRY: 8-10, Corporation Street. Telephone: 0203 25210. GLASGOW: 3 Clairmont Gardens, C.3. Telephone: 041-332 3792. MANCHESTER: 260, Deansgate, 3. Telephone: 061-834 4412. NEW YORK OFFICE U.S.A.: 300 East 42nd Street, New York 10017. Telephone: 867-3900.

CONSUMER ELECTRONICS

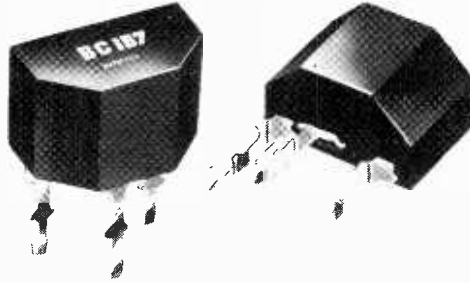
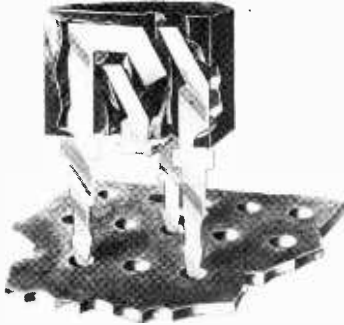

Lock-fit transistors stay where they're put

Putting transistor leads through boards, cropping them and hoping they'll stay put until soldered is out of date. Now just push a Lock-fit transistor in and it stays there. The leads are shaped to grip.

And they won't bend or break. They're designed to pop straight into standard printed circuit grids and p.c. boards of both standard thicknesses. The transistor itself—many of the

wide range of Mullard silicon types—is protected in an epoxy encapsulation which gives good heat conduction. The special epoxy used by Mullard maintains the low spreads of the silicon chip. The shape ensures that operators or machines put the transistor into equipment the right way round. So Lock-fit is easy to mount, gives better solderability and simplifies handling. Lock-fit will save you assembly time and costs. For the full Lock-fit range story manufacturers should tick the coupon.

You may think capacitors inexpensive. But have you worked out the cost of a dud on your line?

We're not going to start the old price v. quality argument again. We'd just like to make sure that you're getting the whole picture. It's up to you to judge what's right for your particular job. But Mullard will help you as much as possible. So bear in mind that, as well as price and technical information, Mullard can also give you the most detailed life/performance data.

This information is fundamental to us if our AQL* is to be maintained—how else could we improve our products? And this information is available to you. Take electrolytics for example. We found that they represent about 70% of all capacitor failures in the life of a TV set. So we produced a detailed report and recommendations on the best way to use electrolytics. You're welcome

to a copy—it covers polyester capacitors too. Just tick the coupon. By getting all the information before you select you can be really sure that you are going to make *savings* by choosing the particular component to meet your design parameters.

*AQL= Acceptable Quality Level.

Time well spent

There can't be many firms who've been in business as long as we have who have used the time to such advantage. Our past experience guides our future plans; provides us with an insight into the industry we serve; allows us to anticipate needs and deploy our resources over the most fruitful areas of research and

development—and thereby provide modern, technically excellent products ready for the demands of tomorrow. We have co-operated in

so many consumer electronics projects that it's quite likely we are working along similar lines to yours. So why not get in touch?

Mullard
CONSUMER ELECTRONICS DIVISION

Please send me
Lock-fit transistor information Capacitor report

Name _____
Position _____
Company _____
Address _____

Mullard Limited, Consumer Electronics Division, Mullard House, Torrington Place,
London W.C.1.

WW9

CED55

WW-111 FOR FURTHER DETAILS

Wireless World

Taped

Editor-in-chief:

W. T. COCKING, F.I.E.E.

Editor:

H. W. BARNARD

Technical Editor:

T. E. IVALL

Assistant Editors:

B. S. CRANK

J. H. WEADEN

Editorial Assistant

J. GREENBANK, M.A.

Drawing Office:

H. J. COOKE

Production:

D. R. BRAY

Advertisements:

G. BENTON ROWELL (*Manager*)

J. R. EYTON-JONES

It is estimated that the total amount of magnetic recording tape made last year would encircle the earth over 760 times, so it would not be an exaggeration to say that magnetic tape pretty well proscribes our lives. While one tends to think of tape primarily as a sound or vision recording medium for entertainment purposes this is, of course, a fallacy for by far the largest application is in the field of information storage of one sort or another. However, in this issue we include a supplement on tape recorders which is limited to the audio field. In it is included a short survey high-lighting the more important aspects of the design and use of tape recording equipment now available, and this is followed by a selection of some of the newer products. We invited manufacturers and U.K. agents of overseas manufacturers to send in information on their equipment and from the data received from the 40% who replied we have selected some of the more interesting of the "quality" instruments. Limitations of space prevented us including all those submitted.

It was not until the end of World War II that information was made available on the remarkable progress in tape recording that had gone on in Germany. We described the general principles in an article in 1946 but a much more comprehensive report, "The Magnetophon Sound Recording and Reproducing System", was produced by the British Intelligence Objectives Sub-committee. This B.I.O.S. report presented the findings of investigators led by M. J. L. Pulling, who recently retired from the B.B.C. In our review of this report we said "There can be no doubt that the use of high-frequency biasing in conjunction with an iron-oxide dispersion as the recording medium is a notable advance in sound recording". This now sounds rather trite but in 1947 the system was revolutionary.

Many were the arguments that went on in the next decade or so on the *pros* and *cons* of tape versus disc, but vested interests inhibited the general introduction of recorded tapes. However, with the coming of cassette loading a break-through was made and it now looks as though this form of transport may well supersede the reel-to-reel method.

It is a coincidence that this month's "Letter from America" opens with some interesting comments on the predominance of tape recording equipment at this year's Consumer Electronics Show in New York. Our correspondent records the growth of the tape cassette type of equipment and goes on to mention the need for standardization. It is to be hoped that vested interests in the different types will not be allowed to militate against the introduction of an international standard.

In his survey in the supplement Ralph West gives some useful guidance in interpreting published specifications for, to the uninitiated, it would appear that the really expensive machine has an inferior performance by comparison with much cheaper domestic models; in fact it has been suggested that the claimed frequency response is inversely proportional to the cost of the machine!

Wireless World Crosshatch and Dot Generator

A low-cost pocket-size television pattern generator built with integrated circuits

designed by B. S. Crank*

As work progressed on the *Wireless World* Colour Television Receiver it became obvious that some form of crosshatch pattern generator would be required by constructors so that the convergence adjustments could be made. Further, if such a generator could be produced in the *Wireless World* laboratory, readers could derive more value from the colour television series and the problem of having to buy, beg, borrow or steal such equipment would be eliminated. Also, if the generator could offer some advantage over a commercial equipment, so much the better.

However, one can seldom obtain something for nothing and in the *Wireless World* crosshatch generator two advantages are exchanged for three disadvantages. The advantages are, small size (11 × 7 × 3 cm) and low cost (≈ £10 or about 20% of the cost of a commercial generator); the disadvantages are, 625-line operation only, the need for an internal connection to the receiver under test and the need for the receiver to be synchronized by a transmitted programme.

Waveform requirements

The generator provides in one mode of operation a symmetrical crosshatch pattern formed by thin horizontal and vertical bars, and in a second mode of operation a dot pattern formed by regularly spaced dots. The horizontal bars are produced by brightening the television scanning lines at intervals down the raster, while the vertical bars are formed by brightening small parts of the lines at intervals across the screen. The dots are produced by brightening the scanning lines at what would be the intersection points of the horizontal and vertical bars in a crosshatch pattern.

The generator therefore has to provide a video waveform that will result in a series of narrow horizontal and vertical bars on the screen. It has already been mentioned that the receiver is synchronized to a transmitted programme, so the generator does not have to produce any synchronizing pulses. However, to make the crosshatch pattern stationary the generator has to be synchronized with the receiver. This is done by employing a two- or three-turn coil held close to the receiver line output transformer to pick up line flyback pulses.

To form the horizontal bars the line fly-

back pulses, after shaping, are divided by 25 to produce a video pulse every twenty-fifth line of the field scan. Taking account of the interlacing of two fields to form a complete picture, this results in a horizontal bar at every twenty-fifth line of the displayed raster. A gating system ensures that the video pulse is equal in length to the time between every twenty-fifth and twenty-sixth line flyback pulse. Using this method twenty-four bars are drawn on the screen; the twenty-fifth (25 × 25 = 625) is lost in frame flyback.

The screen of a 19-inch c.r.t. is 12 inches high and 18 inches wide and, as twenty-four horizontal bars are produced they will be 0.5 inch apart. If the crosshatch is to be symmetrical the vertical bars should also be the same distance apart. 18 inches ÷ 0.5 inch = 36, so 36 vertical bars are required.

The line timebase of a 625-line receiver goes through one cycle of operation every 64μs. However, only about 54μs of this represents scanning time, as some 12μs are taken up in flyback. To produce 36 vertical bars a video pulse is required 36 times every 54μs, or once every 1.5μs. This corresponds to a frequency of about 670kHz.

Therefore, in order to produce the vertical bars, an oscillator running at 670kHz, synchronized with the line flyback pulses, is arranged to produce one video pulse, about 0.2μs wide, for each cycle of operation.

Integrated circuits

Fourteen integrated circuits are used in the construction. They are manufactured by SGS-Fairchild and are readily obtainable from a number of our advertisers. The devices are in eight-lead plastics packages of about TO-5 size. Two types are employed; these



The prototype

are the μL914, which is a dual two-input NOR gate, and the μL923, which is a J-K flip-flop. (Note that this is the American usage of the term flip-flop, meaning a bistable multivibrator.)

The circuit of the μL914 is shown in Fig. 1. A positive input applied to pins one or two, or both, will cause the output on pin seven to fall to 0V. In the absence of a voltage on pins one and two, pin seven will be at +V. The same rules apply to pins three, five and six.

It is not proposed to give a long and detailed description of how the J-K flip-flop

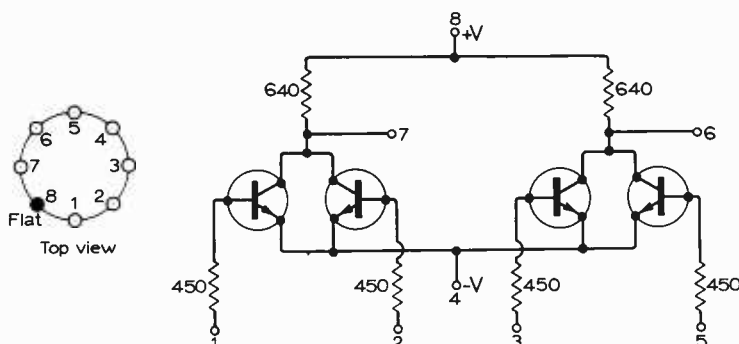

Fig. 1. Theoretical circuit of the Fairchild μL914 dual two-input NOR gate.

*Assistant Editor, *Wireless World*.

operates; however, what it does will be explained. The symbol is shown in Fig. 2. A bistable can have one of two states; if one output is 'up' ('up' signified by the presence of a positive voltage) the other will be 'down'. The output wires are shown as 1 and 0 in Fig. 2. When the bistable is reset the 0 output will be up and the 1 output down; when it is set the opposite is true. If a train of pulses is applied to the trigger terminal T the flip-flop will change its state on each negative transition of the pulse train.

Assume the bistable to be set, that is 1 up, 0 down, and a positive voltage is applied to the reset terminal R. The flip-flop will remain in the set condition until, in addition to the voltage on R, a negative-going edge is applied to T, then the flip-flop will reset. Any number of additional pulses fed to T will not set the flip-flop while the voltage exists at R. In the same way a voltage at the set terminal S will cause the flip-flop to take up the set position, and remain there for as long as a voltage exists at S, on the first negative transition applied to T.

The preset terminal P is not gated with the trigger pulse input in any way. A positive voltage applied here will instantly reset the flip-flop regardless of other conditions.

Horizontal bars

A counter chain of three J-K flip-flops connected as in Fig. 3 will divide by eight; that is, it will provide one output pulse for each eight pulses received at the input. To form the video pulses for the horizontal pattern a division ratio of 25 is required. In the generator the divide-by-eight counter of Fig. 3 is modified to divide by five, and two such counters operating in series are used to obtain the required 25:1 division ratio.

Each input pulse to bistable A of Fig. 3 will cause bistable A to change state, or toggle. For every second pulse applied to the input a negative-going edge will be applied to the trigger input of bistable B, causing it to toggle, and so on. If a flip-flop when set is said to be in a 1 state and when reset to be in a 0 state a table can be drawn up to show the state of each bistable after each input pulse.

Input	C	B	A
0	0	0	0
1	0	0	1
2	0	1	0
3	0	1	1
4	1	0	0
5	1	0	1
6	1	1	0
7	1	1	1

To make the counter divide by five it is necessary to force it to repeat its cycle after every five input pulses—that is, in the table, to take up the 000 position directly after the 100. This is achieved in the circuit of Fig. 4. Assume that all bistables are reset; the 0 outputs of A and B will be up and the output of NOR 1 will be down. The input to NOR 2 is down so its output, and the reset input of C, will be up. The first input pulse toggles A, and because the reset terminal of C is up this flip-flop remains reset. A is now set and its 0 output is down. However, the reset C terminal is still held up because of the up input from flip-flop B to NOR 1. On the next input pulse A resets and B sets. There is now an

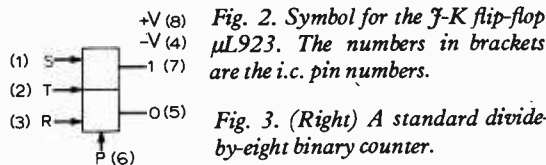

Fig. 2. Symbol for the J-K flip-flop $\mu\text{L}923$. The numbers in brackets are the i.c. pin numbers.

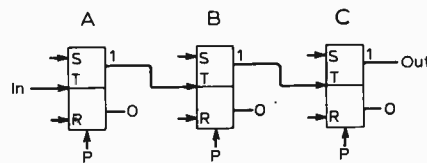

Fig. 3. (Right) A standard divide-by-eight binary counter.

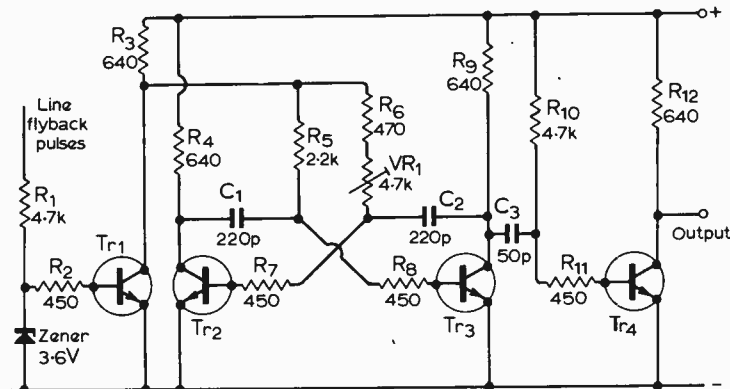
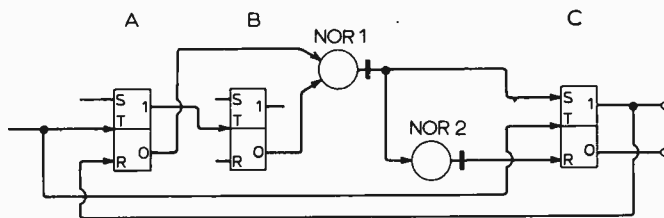

Fig. 5. Circuit of the vertical bar generator in discrete component form.

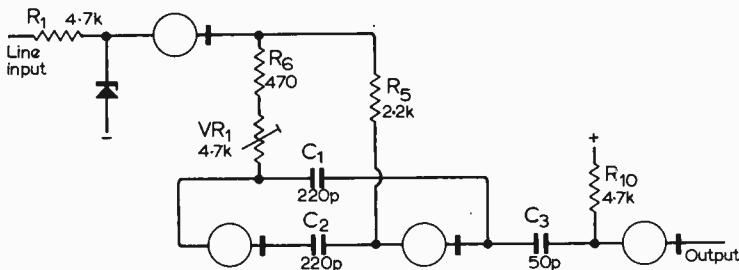

Fig. 6. Logic diagram of Fig. 5.

input to NOR 1 from A so the C flip-flop remains reset. The third input pulse sets A. Now A and B are both set, so the inputs to NOR 1 go down and the set terminal of C goes up. The fourth input pulse sets C and resets A and B; the counter now holds 100. The 1 output of C, and therefore the reset input to A, are now up; also because A and B are reset the reset input of C is likewise up. The only effect of the fifth pulse, therefore, is to reset flip-flop C. The counter is now back in its initial state with all flip-flops reset, and the next pulse will start the cycle of events again.

Vertical bars

The circuit of the vertical-line pattern generator is shown in discrete component form in Fig. 5. With no voltage on the line-flyback input the collector of Tr_1 will be almost at the full positive supply-line potential as will the top ends of R_5 and R_6 . Under these conditions Tr_2 and Tr_3 will function as a conventional astable multivibrator operating at about 700kHz.

Positive-going pulses, picked up by a loop of wire held near the line output transformer of an operating television receiver, are fed to R_1 and limited by the zener diode D_1 . During

each line-flyback pulse Tr_1 saturates and the collector of Tr_1 , together with the top end of R_5 and R_6 , fall to earth potential. The Tr_2 , Tr_3 , multivibrator is now starved of base supply voltage and ceases to function for the duration of the flyback pulse. Synchronizing the multivibrator by feeding the flyback pulse, after limiting and differentiation, to one of the multivibrator bases through an unused gate input proved rather unreliable, as a locked-off condition was sometimes obtained with both Tr_2 and Tr_3 saturated. The method finally adopted was found to afford reliable synchronization.

Tr_4 is normally held switched-on by R_{10} . However, during negative-going excursions of Tr_3 collector, every $1.42\mu\text{s}$, Tr_4 is switched off for a time determined by the circuit time constants, these being chosen to give approximately a $0.2\mu\text{s}$ pulse at Tr_4 collector. The logical diagram of the vertical pattern-generating section is given in Fig. 6.

Complete circuit

The complete logical diagram of the pattern generator is given in Fig. 7. The line flyback pulses after being shaped by the zener and integrated circuit NOR 2 (a) are again inverted in i.c. NOR 5 (a) to drive the first divide-by-five

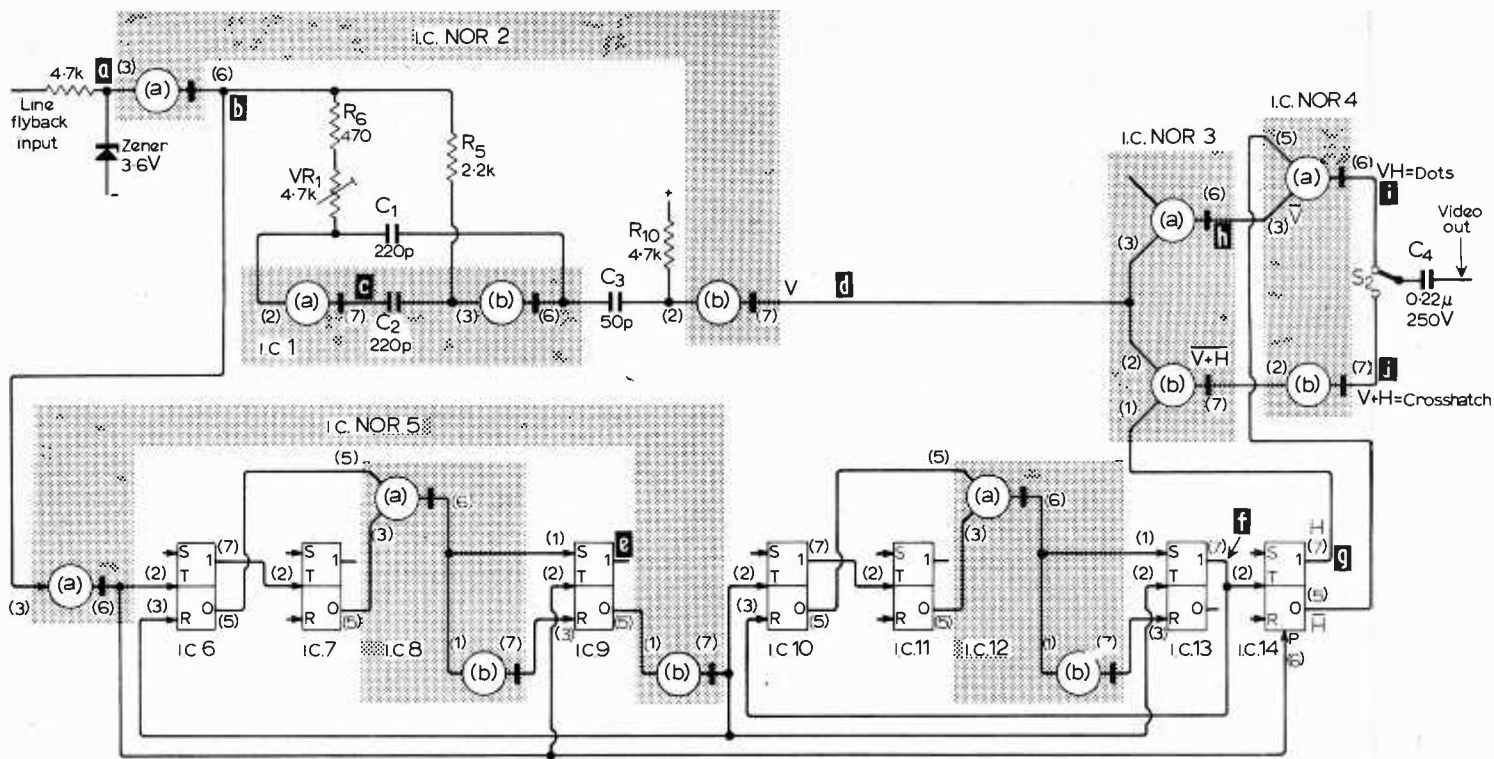

Fig. 7. Complete logic diagram of the crosshatch and dot generator, showing the dual NOR gate integrated circuits as shaded areas. The figures in brackets are i.c. pin numbers and the white letters are the points at which the waveforms of Fig. 10 were taken.

counter. This differs slightly from the circuit given earlier (Fig. 4) in that an extra NOR gate, i.c. NOR 5 (b), has been incorporated. If this were not done the loading on i.c. flip-flop 9 would exceed the manufacturer's ratings. Because of the inversion this gate provides it is fed from the 0 output of the flip-flop instead of the 1 output. To ensure that each vertical line video pulse is only one scan line in duration i.c. flip-flop 14 is incorporated.

On each 25th line flyback pulse i.c. bistable 13 resets, setting flip-flop 14 to provide a video output pulse. The 26th line flyback pulse is fed to the preset terminal of bistable 14, resetting it.

To produce a crosshatch pattern it is necessary to feed the outputs of both the vertical and horizontal video generators to the receiver's video amplifier. This is done in the OR gate formed by i.c. NORs 3(a) and 3(b).

To produce a dot pattern a video pulse is required only when there is an output from both the horizontal and the vertical bar generator simultaneously. That is, a video pulse is generated so that a dot is produced at every point on the screen where the horizontal and vertical bars cross when in the crosshatch mode. The necessary gating is performed in the AND gate formed by i.c. NORs 3(a) and 3(b). NOR 3(b) can provide an output only when pulses from both the vertical and the horizontal pattern generators are present at the inputs of NOR gates 3(a) and 3(b).

The power supply has some degree of regulation and is shown in Fig. 8. The output is adjusted to 3.6V using RV_2 .

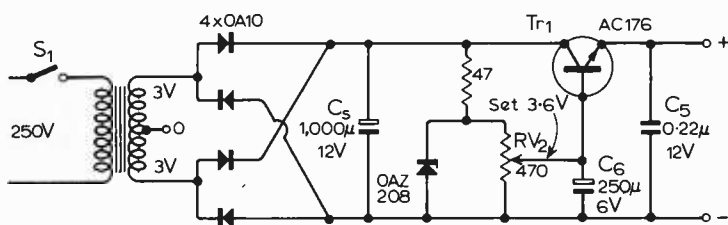

Fig. 8. The power supply.

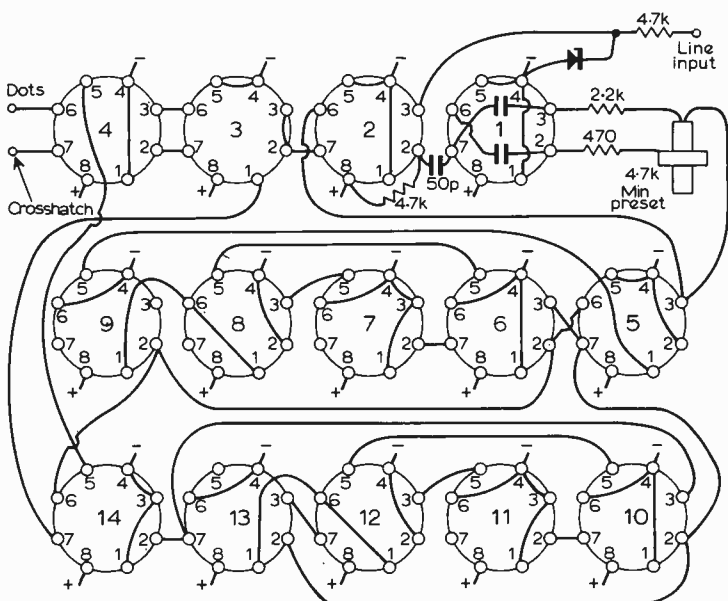

Fig. 9. Wiring details of the integrated circuit section of the generator.

Constructional notes

All the components, with the exception of the mains transformer, C_4 , the switches and sockets, were mounted on a piece of 0.1-in. matrix unclad Veroboard measuring $2\frac{1}{2}$ in. \times $2\frac{3}{4}$ in. The components were soldered to Vero pins (part No. 2141) inserted into the board. For convenience the signal wiring was carried out on the upper side and the power-supply wiring on the underside of the board. There is no reason why a printed circuit could not be used if desired.

The mains transformer is a sub-miniature type, that will provide 3-0-3V at 200mA; it measures only 28mm \times 27mm \times 20mm. In this application the centre tap is unused and the transformer is used to supply 6V. The preset potentiometers RV_1 and RV_2 are the miniature open skeleton type for horizontal mounting (13mm \times 9mm \times 3mm). The switches are miniature s.p.c.o. toggle switches (24mm \times 9mm). All the above three components were obtained from Radiospares.

Throughout the construction it should be borne in mind that there will be pulses

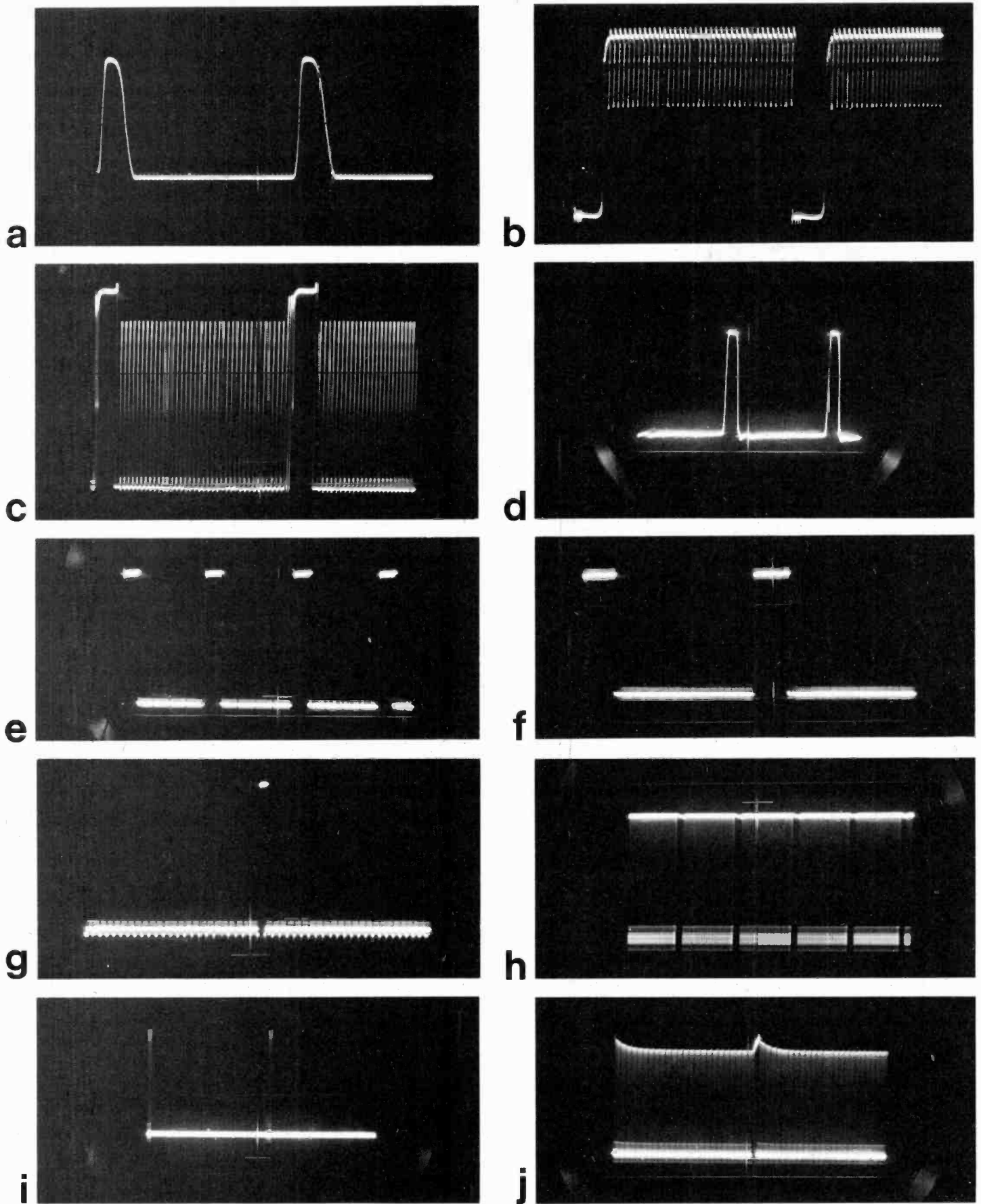
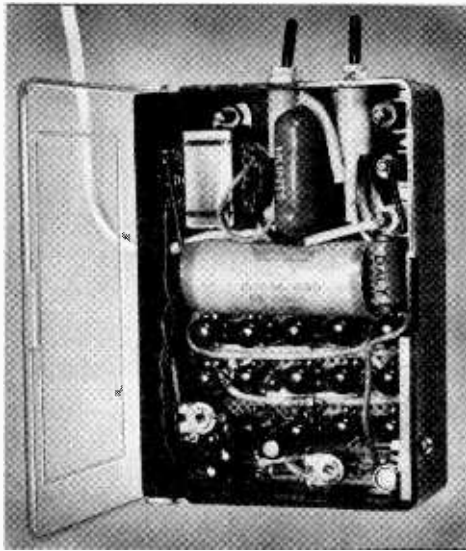

Fig. 10. Waveforms encountered in the unit: (a) line fly-back pulses after clipping at the input to gate 2(a); (b) multivibrator synchronizing waveform—the 'noise' at the top of the pulse is the voltage drop across gate 2(a)'s load resistor produced by the multivibrator base current; (c) multivibrator output; (d) $0.2\mu\text{s}$ pulses at the output of gate 2(b); (e) line pulses after division by five, time base 1ms; (f) line pulses after division by 25, time base 3ms; (g) pin 7 on i.c. 14; (h) pin 6 on i.c. 3; (i) pin 6 on i.c. 4; dot waveform—the shaded 'pulses' are about $52\mu\text{s}$ wide and consist of 36 $0.2\mu\text{s}$ pulses, time base 3ms; (j) pin 7 on i.c. 4, crosshatch waveform.



Showing the general layout.

is always negative and pin eight positive. Incidentally, pin eight is directly underneath the flat in the plastics encapsulation; sometimes, though, it is identified by a coloured spot of paint. The completed generator was housed in a small plastics case the dimensions of which have already been given.

Setting-up and use

After a check of the wiring—for integrated circuits object to having the power supply accidentally connected to an output terminal—the generator can be switched on. The first task is to set the supply voltage between 3 and 3.6V; this is done by adjusting RV_2 . Do not leave the generator switched on too long before this adjustment is made as excessive dissipation in Tr_1 could occur.

If the generator is being used with the *Wireless World* colour receiver the video output of the generator should be coupled to the grid of the luminance video output valve via a 100- Ω grid-stopper resistor. This is possible in the *Wireless World* receiver because a grid stopper (450 Ω) is used in the normal video lead from the video pre-stage and this assists in the isolation of the generator from the receiver's earlier circuits. In some commercial receivers the luminance delay line is connected to the grid of the video output valve and in such cases the generator cannot be connected directly to the grid. In these circumstances another input point must be found after the video detector. This will be at some point probably at the base of an accessible transistor. Because of the variation to be found between one make of receiver and another it is impossible to lay down any hard and fast rules.

If the generator signal is injected just after the detector it must be attenuated to avoid overloading the video amplifier. This can be done in one of two ways: firstly, a resistor can be connected in series with the generator

output lead and its value found empirically, or, secondly, an output attenuator can be incorporated with little circuit modification as shown in Fig. 11.

The generator normally supplies a positive-going video signal. If the output of the generator is injected at some point other than the video valve grid it is possible that a negative-going signal will be required. The necessary circuit changes to convert the output of the generator from positive- to negative-going video are shown in Fig. 12. The inversion applied to the output of gate 3 (b) is removed and the output of gate 4 (a) is inverted in gate 4 (b).

If an extra switch is added, as in Fig. 13, the circuit will provide a choice of either positive- or negative-going video. The four-pole two-way switch S_3 switches the circuit from that shown in Fig. 7 to that of Fig. 13.

Returning to using the generator, it is necessary to couple the line input of the generator to the line output stage of the receiver.

This can be done by two or three turns of plastics covered wire held near the line output transformer or by winding a few turns of the same wire round the lead to the top cap of the line output valve. The receiver is switched on and synchronized and the selected pattern is then displayed. It is advisable to turn the contrast down to minimum to prevent the programme material from being shown on the screen.

If all is well VR_1 is adjusted until 36 vertical bars are shown on the screen. Inadequate coupling to the line output stage will be seen as no vertical bar synchronism and no horizontal bars at all. It will be found that the horizontal bars will suffer from interlace flicker, not to be confused with jitter, that will be accentuated if the pattern is viewed under 50Hz lighting. However, the effect was not found troublesome.

In the event of things going wrong the oscillograms of Fig. 10 should prove useful. The identification letters indicate the circuit points on Fig. 7 at which the waveforms can be observed. These oscillograms were taken at an early stage in the development using almost expended batteries as the power source. Also the video lead to the receiver was about 5ft long. Under these extremely adverse conditions the generator functioned well. Some improvement of the waveforms occurs when the generator is run under normal conditions. Incidentally, the low cost of the generator, 3% of an average television receiver, means that it could be built into a set permanently so that convergence could be checked at any time.

Our front cover this month is a photograph of the screen of the *Wireless World* colour television receiver showing the crosshatch pattern produced by the generator. The photograph was chosen because it was pleasing to the eye, it also illustrates the sort of problem to be faced when tackling an unconverged receiver for the first time. Adjustments have to be made, in sequence, a little at a time, the sequence being repeated as often as necessary. Patience and practice are the tools that ensure success, as achieving correct convergence on a colour TV set is more an art than a science.

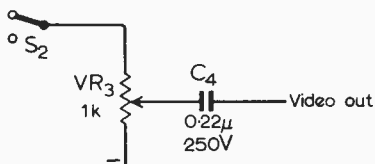

Fig. 11. How to add an output attenuator.

in several parts of the circuit with rise times in the 15ns region, representing several tens of megahertz. Accordingly all wiring should be as short and direct as possible.

In the power supply Tr_1 , the regulator transistor, is perhaps not quite man enough for the job it has to perform. It was, therefore, mounted on a fairly substantial heat sink made of $\frac{3}{2}$ in. thick brass $1\frac{1}{2}$ in \times $\frac{1}{2}$ in using a standard heat sink clip.

The layout of the integrated circuits is shown in Fig. 9. For clarity the power-supply wiring is not included. However, pin four

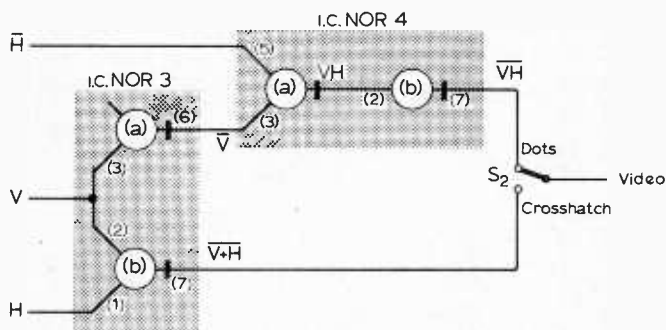

Fig. 12. Converting the output arrangement given in Fig. 7 to one providing negative going video.

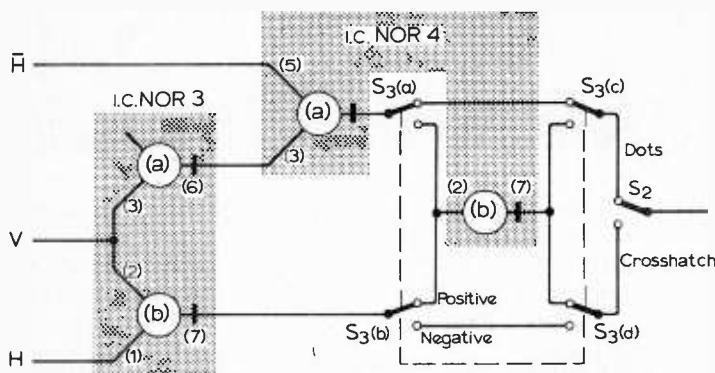

Fig. 13. Adding a switch to give either a positive or negative going video signal.

Voltage Following

A questioning look at the emitter-follower and an outline of alternatives that have been used

by Peter Williams*, B.Sc.

Single transistors of either polarity may be used as emitter-followers (Fig.1). The collector is at ground potential for a.c. purposes (via the supply) and this configuration may then also be called grounded collector. The emitter-follower is often used as a buffer to present a high input impedance to a source where the circuit input impedance is much lower (Fig.2). Conversely, used at the output, it has to drive the load, providing a low output impedance irrespective of that of the circuit (Fig.3). Inside an amplifier it may isolate two stages, to permit the former to reach a high voltage gain fixed only by the values of resistance used (Fig.4). Thus the ideal emitter-follower would have input and output impedances that are infinite and zero respectively. This is not enough since there might be a constant potential difference between input and output. A further embarrassment in d.c. applications would be temperature induced drift in this p.d. Hence a third property of an ideal emitter-follower would be equality of input and output potentials regardless of temperature. Where a circuit comes close to meeting all these conditions it merits the description voltage follower, a name that has found favour with the designers of operational amplifiers operating with 100% series, applied, shunt-derived negative feedback. In Fig. 5 a high gain amplifier with single ended output and differential input, has its inverting input tied to the output. The p.d. between input terminals is much less than V_o , leaving V_o substantially equal to V_i . The circuit is then dubbed a voltage follower.

Limitations

A single transistor in the common collector configuration cannot satisfy any of these conditions completely. Thus to a first approximation, the input impedance will equal the load impedance multiplied by the common-collector current gain; the output impedance approximates to source impedance divided by the current gain. If in Fig. 6

$$V_o = V_i \text{ and } i_e = h_{fe} i_b$$

$$Z_i = \frac{V_i}{i_b} = \frac{i_e Z_L}{i_b} = h_{fe} Z_L$$

As the load resistance is increased, a limit on input impedance is imposed by the shunt path between base and collector. Similarly a lower

limit to output impedance is fixed by the $r_{e\prime}$ term of the equivalent-T circuit. The output potential of an emitter-follower differs from that of the input by the base-emitter p.d. of the transistor. This may lie between 0.5V and 0.7V for silicon devices depending on the type and operating current, and falls typically by 2mV for each rise in temperature of 1 deg C. This need not be a disadvantage for a.c. circuits but clearly is so when it is a d.c. level that is to be transferred. The single emitter-follower presents problems for d.c. signals below a few volts.

The Darlington circuit

First consider the usual Darlington configuration of two transistors (Fig. 7). The combination may still be treated as a single transistor but having a current gain approximating to the product of the individual gains. A detailed analysis has been made¹ of

this super alpha combination. The minimum p.d. between input and output circuits is now twice that for a single transistor and the temperature drift in that p.d. is also doubled. A simple alternative, Fig. 8, has a comparable current gain but with only one base-emitter path between input and output. It is perhaps best considered as two inverting stages having a high overall voltage gain but with 100% series-applied feedback. This gives a voltage gain just less than unity. Note that a complementary version of the above circuit is equally valid.

Both of these two-transistor circuits can lay traps for the unwary. In the earlier paragraphs a combined current gain equal to the "product of the current gains" has been glibly quoted. This statement needs qualification. As drawn, the first transistor in Fig. 7 has an emitter current equal to the base current of the second. Operating at a low current level it may then have a value of current gain much less than that obtaining at normal currents. A more fundamental over-simplification in the above has been the assumption that the actual value of current gain is comparable with the h_{fe} of the transistor. This is true only for a short circuit output, the way in which the h_f parameter is defined. In most cases the observed current gain is reduced below the h_f value by less than the spread in h_f occurring in the manufacturing process. A useful guide to typical performance might then be to expect the actual current

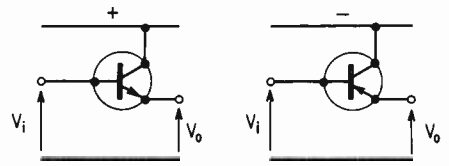

Fig. 1. Emitter-followers. The collectors are at ground potential.

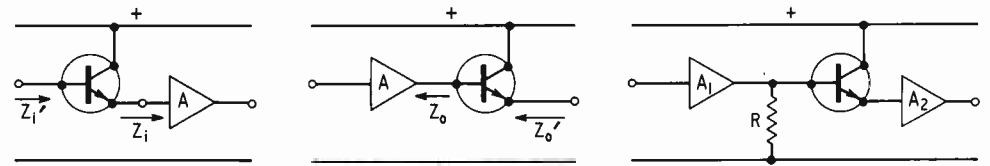
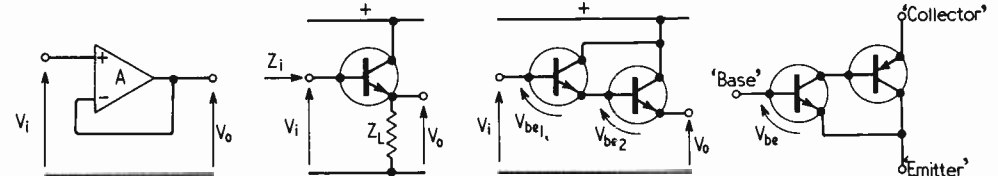

Fig. 2. (Left) A buffer stage for presenting high input impedance to the source. Fig. 3. (Centre) A buffer stage for presenting low impedance at the output. Fig. 4. (Right) If the voltage gain of A_1 is a function of load resistance R , a single emitter-follower can effectively isolate A_1 from the loading effect of A_2 .

(Left to Right) Fig. 5. A differential amplifier wired as a voltage follower. Fig. 6. A common collector circuit with load Z_L . Fig. 7. A Darlington transistor pair. Fig. 8. A complementary pair of transistors with feedback from the output collector to the input emitter.



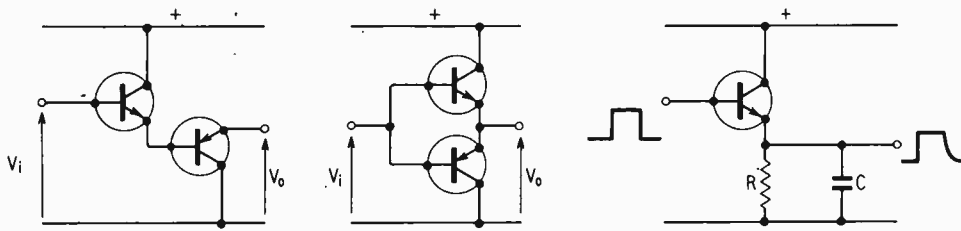

Fig. 9. (Left) Two transistors of opposite polarity in cascade. Fig. 10. (Centre) A bi-directional emitter-follower used where high drive currents are required in both directions. Fig. 11 (Right) A class A stage feeding a capacitive load.

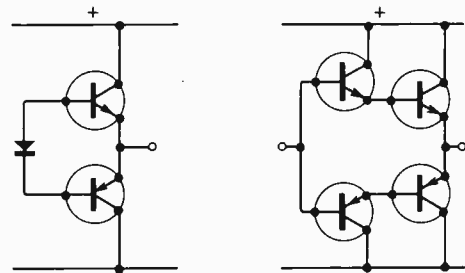

Fig. 12. A forward biased diode between the bases provides bias approaching class B. Fig. 13. A Darlington version of Fig. 10.

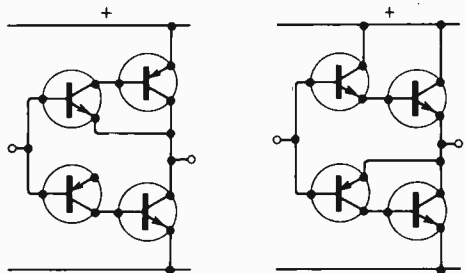

Fig. 14. The configuration in Fig. 8 can be used to provide the high gain and bi-directional action.

Fig. 15. Quasi-complementary symmetry using identical output transistors.

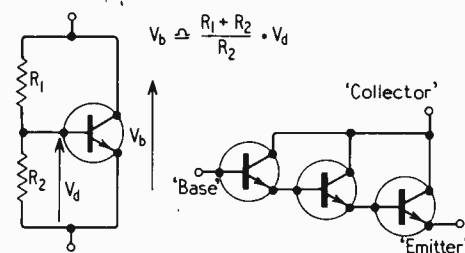

Fig. 16. (Left) The "amplified diode" provides variable bias voltage equivalent to a string of diodes. Suitable for use in the circuits of Figs. 12 to 15.

Fig. 17. (Right) The Darlington triple in which the overall current gain approximates to h_{fe}^3 where h_{fe} is large.

gain to lie close to the minimum specified value of h_{fe} .

Fig. 9 shows a cascaded emitter-follower using complementary transistors in which the V_{be} drops in the two transistors largely cancel. The characteristics of n-p-n and p-n-p will not match exactly and the two are operating at different currents. There will thus be some residual offset voltage between input and output and a drift in this offset, though both should be in order of magnitude less than for

any of the previously described circuits. This circuit could be used to drive a d.c. voltmeter of low resistance from a high resistance source with a voltage error of perhaps a couple of tens of millivolts. Complementary versions simplify the choice of transistor since the type having highest current gain at low currents can be used as the first transistor.

Push-pull operation

Operating in class A, a single emitter-follower, or these alternatives, can transfer a sinusoidal or other bi-directional signal to a load. There are many cases where operation in class B or C is desirable and Fig. 10 shows a combination of two complementary transistors which are biased just into class C. A particular example where class-A operation is undesirable is the transmission of pulses into capacitive loads (Fig. 11). On the positive-going input step the transistor can supply sufficient current to charge the capacitance rapidly. On the negative going step the capacitor will temporarily hold the emitter above the base potential until the exponential decay at a rate determined by the RC time-constant is completed. Throughout this time the transistor is out of conduction and plays no part in determining the output. To shorten the fall-time of the pulse, the resistance of R can be reduced since the two are proportional. In so doing the current drawn during the pulse is considerably increased and transistor dissipation and supply current drain follow suit. This is an inefficient way of discharging the capacitor since a large transient current is being provided at the expense of large mean current. The circuit of Fig. 10 has complementary symmetry permitting one transistor to charge the capacitor rapidly during the pulse mark with the other discharging it equally rapidly during the space. The circuit finds applications in transmitting pulses along highly capacitive cables.

Because the biasing is class C, distortion ($\sim 2V_{be}$) results with sinusoidal signals. Fig. 12 shows the basic method used to ensure class B or AB operation. The bases are separated by a diode in forward conduction, normally being part of the resistive load of the previous stage. The voltage across that diode may be made sufficient for each transistor to conduct slightly taking them to the borderline of class-B. Unfortunately the non-linearity of the voltage-current characteristic for transistors still results in cross-over distortion unless they are biased forward into class AB. A difficulty in this arrangement is that the current is a function both of the diode forward voltage and the V_{be} for each transistor.

Turning to Figs. 13-16, we have a group of circuits which represent the extension of the bi-directional circuits just discussed to those cases where increased current gain is required. Thus Fig. 13 has each single transistor replaced by the appropriate Darlington pair, while in Fig. 14 the complementary Darlington pairs are used. The relative merits and demerits of the circuits of Figs. 13 and 14 hinge on the properties of the Darlington pairs as outlined earlier. In particular that of Fig. 13 has four base-emitter paths between input and output, which would make the selection of a diode biasing network in the input bases difficult. A problem common to the two circuits is that the output transistors in each are of opposite polarity. Since this basic form of circuit is of such general application in audio power amplifiers the need arose for complementary transistors of high power rating. This need has still not been completely fulfilled—at least not as cheaply as one would like. In the early years, when only germanium devices were available, these were mainly p-n-p although some low-power n-p-n devices were produced. H. C. Lin of U.S. General Electric devised the quasi-complementary output stage shown in Fig. 15. The two halves of the circuit are no longer identical though for similar transistors the current gains will be comparable. It has the key merit that the output transistors can be of the same type which may readily be obtained as a matched pair. The key to the quasi-complementary circuit is that a power transistor of one polarity may be made to behave as one of the opposite type by incorporating it in a 100% series-applied feedback circuit with a low power device of the opposite type. If the problems of biasing are difficult with class B circuits having two transistor base-emitter p.d.s. within the bias loop, they can appear insurmountable with three or four present. A compromise involving two or more diodes together with series resistors is often adopted but an idea has recently been put forward that is elegant and effective^{3,4}. Fig. 16 shows a transistor with resistors between base and emitter, and emitter and collector. If the base current is a small fraction of the potential divider current, then the collector-emitter voltage is a defined multiple of the base-emitter voltage, i.e. we have a two-terminal device which over a reasonable range of operating currents has a voltage drop and corresponding drift with temperature, equivalent to a series chain of n diodes where n includes non-integral values depending on the ratio of R_1 to R_2 . The designer of this circuit has made a notable contribution to the armoury of those fighting the great enemy—bias-point instability. A suggested name for this circuit is "the amplified diode" since with it we can provide a voltage which is any desired multiple of that across a normal semiconductor diode when forward-biased.

Triples

Another major use of compound emitter-followers is in the output stages of d.c. voltage regulators. Load currents of several amps may be needed while the driver stage may conveniently deliver less than a milliamp. Two transistors will not then provide sufficient current gain, particularly since the transistors

may have to operate close to saturation to minimize voltage loss in the output. Hence a Darlington triple is sometimes employed (Fig. 17). Unless the base can be supplied from some auxiliary constant current source the minimum difference between supply and output may be in excess of 1.8V—three base-emitter voltage drops. Allowing for some voltage drop across the base drive resistor this voltage may rise to 2.5V or more making this triple a particularly undesirable one at low supply voltages. Just as a complementary Darlington offered some advantages over the "straight" one, so complementarity is worth investigating in more detail here. We shall limit ourselves to combinations of three transistors in which (a) the output of each (collector or emitter) shall be coupled into the base of the next, i.e. excluding common base connection (b) each transistor shall provide the bias current for the next.

We can derive the configurations which meet the above conditions by returning to Figs. 7 and 8 and considering the Darlington and complementary Darlington pairs having n-p-n polarity. If we replace each transistor, of which there are four in the two circuits, in turn by a Darlington pair and then by a complementary Darlington pair, then we generate eight triples having n-p-n polarity. Of these, six only are shown in Fig. 18 since two of them are duplicated [(a) and (f)]. A complementary set of six can be drawn having p-n-p polarity. The triple shown in Fig. 23(f) has already been discussed. Of the remaining five, Fig. 23(b) has much to commend it. It is used in regulators and has been recently advocated in a letter drawing attention to its merits. In particular the p.d.s. between "collector" and "emitter" (0.7V) and "base and emitter" (0.6V) are the lowest possible for a triple. These approximations assume a V_{be} of about 0.6V and a V_{ce} of 0.1V in saturation. For example in 18 (e) the comparable values are 1.3V and 1.2V respectively for the equivalent collector-emitter and base-emitter minimum p.d.s.

Where the high gain offered by a triple is needed it must be remembered that the standing current in the first transistor will be very low. This can result in loss of current gain in that stage sufficient to offset much of the advantage in going from a pair to a triple. If resistors are placed between base and emitter

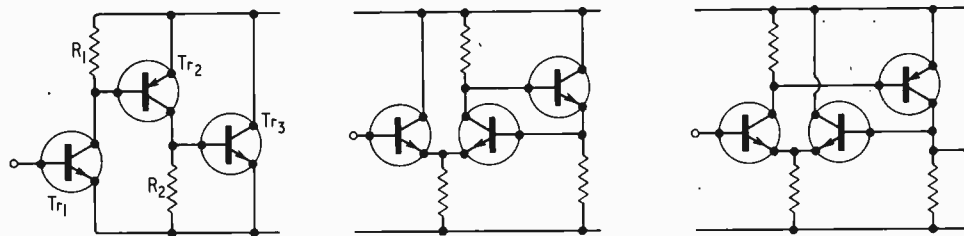

Fig. 19. (Left) The addition of resistors stabilizes the characteristics of Fig. 18 (b). Fig. 20. (Centre) A feedback amplifier using a long-tailed pair to compare input and output. Fig. 21. (Right) A circuit with many advantages. An inverting output stage is taken from the collector of the input transistor. The output and input can approach the positive line.

of each transistor as in Fig. 19 the operating currents of the earlier stages are raised but stabilized. Each resistor is chosen to carry a d.c. current, say, one to five times the expected base current of the following stage—the higher ratios being usable with very high gain transistors. For example, if T_2 has a collector current of 10mA it might have a base-emitter p.d. of about 600mV and a dynamic input resistance of a couple of hundred ohms. With a current gain of 100, the base current would be 0.1mA and a base emitter resistance R_1 of 2,000 would carry a d.c. current of 0.3mA. The shunting effect of R_1 on the base of T_2 would be small since R_1 is ten times the assumed dynamic input resistance at this base.

Voltage-follower

A completely different approach is needed when the main requirement is accuracy of transfer from input to output rather than, as in the previous circuits, maximizing of current gain. The circuits of Fig. 13 used complementary cascaded transistors in which the V_{be} is largely cancelled. Exact cancellation is extremely difficult since in general complementary transistors will differ in their manufacture and hence in characteristics. If a circuit is devised in which the V_{be} cancellation is achieved by transistors of the same polarity, then matched pairs taken from the same production batch or even produced on the same chip should solve the problem. Two of the simplest circuits in which such a matched pair can be used, while providing emitter-follower characteristics overall, are shown in Figs. 20 and 21.

A defect of the circuit of Fig. 20 is that the output swing is limited (a) by the base-emitter voltage of the long-tailed pair which prevents input (and hence output) from falling below 0.6V (b) the necessity for current in the "tail" to keep the transistors in conduction (c) the voltage drop across base-emitter of the output transistor and its base-drive resistor. The first two terms cannot be eliminated, though the second can be eased if the "tail" is replaced by a constant-current source with low voltage drop. They specify the minimum value of input voltage below which the output will not adequately track. Fortunately the third limitation can be removed by a very simple change in the circuit. Replace the output transistor by one of opposite polarity, used as a common-emitter stage. This puts an additional signal inversion which would provide positive feedback. Accordingly the output transistor is fed from the collector of the input transistor instead leaving the overall feedback as negative (Fig. 21). This three-transistor circuit has a current gain provided by only two transistors, but the accuracy of matching of temperature drift makes it a very useful circuit. As it stands, supply variations may cause a change in current in the tail depending on whether the signal is applied with respect to the positive or negative rails. If the tail current increases, most of that increase is channelled into the right hand transistor of the pair since the other is forced to provide a relatively constant current. This is to maintain a base-emitter voltage for the output stage of just over half a volt. The current is thus unbalanced in the long-tailed pair and there is an input-output differential. For voltages above a volt or two, the output is not likely to differ from the input by more than, say, ten millivolts giving a voltage gain of 0.99 or greater. The input-impedance will be high and the output-impedance low.

Common-collector

In all the circuits described so far both source and load have had one terminal at ground potential. Thus a single transistor used in this way may be called by three correct names (a) emitter-follower (b) grounded-collector stage (c) common-collector stage. It is the last of these that is the most general since as will be indicated there are circuits which are common-collector but in which the collector is not grounded. In these the emitter is grounded thus disposing of the term emitter-follower.

Returning to the common-collector form of circuit a block diagram is given in Fig. 22

Fig. 18. Six combinations of three transistors having characteristics similar to a single n-p-n transistor. A complementary set of six can be derived to function as a high gain p-n-p transistor. Type (b) has many advantages for regulator circuits.

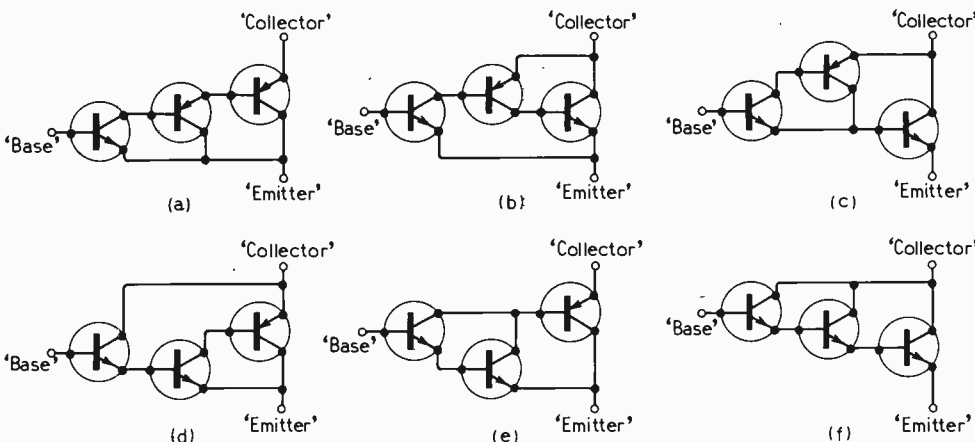

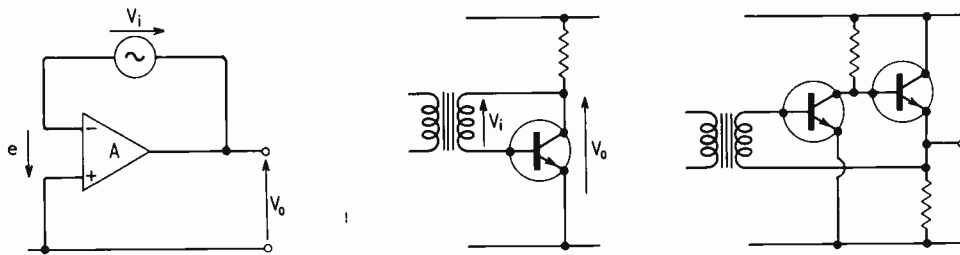

Fig. 22. (Left) The circuits in Figs 1 to 21 have referred input and output to a common line. This need not be ground. Fig. 23. (Centre) This circuit is in common collector but not grounded collector. Fig. 24 (Right) A d.c. feedback arrangement.

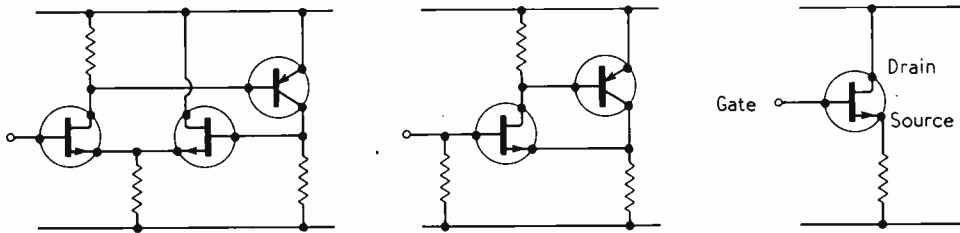

Fig. 25. (Left) F.E.T.s may be used together and in combination with bi-polar transistors to duplicate circuits designed earlier. Fig. 26. (Centre) In this circuit the G_m is boosted by the addition of a p-n-p transistor. This may be cheaper than a high g_m f.e.t. Fig. 27 (Right) A single field effect transistor stage with an output impedance of approximately $1/g_m$.

to illustrate the principle. The source is floated between output and inverting input of a high-gain amplifier. Two features emerge which tie in with the properties of an emitter-follower:—(a) because the gain is assumed high, the output voltage roughly equals the source voltage, differing from it only by the small voltage across the amplifier input terminals (b) the input current and hence the current drawn from the source is small since this current is caused only by the small voltage appearing across amplifier input terminals. A practical circuit is shown in Fig. 23 where the secondary of an input transformer is directly connected between collector and base of a transistor. The current drawn from the source now depends only on the transistor base current while it is the collector that supplies the load current. The voltage V_i and V_o are approximately equal. If the source is a moving-coil microphone or other component providing a low resistance d.c. path, it may be substituted for the transformer. In such a case we have an extremely simple impedance transforming circuit in which the only component additional to source and load need be the active device. The output impedance is low since the feedback (through the source) is shunt derived i.e. as the collector current increases and the collector voltage tries to fall, this fall is transferred back to the base reducing the collector current and opposing the original change. Assuming negligible d.c. voltage drop in the source (or transformer secondary) the collector potential is equal to the base potential. For input signals of only a hundred millivolts or so the minimum collector-emitter voltage still keeps the transistor out of bottoming. With silicon transistors this allows the collector to swing below the base by up to three or four hundred millivolts. Where the current gain is not high enough nor the output impedance low enough, the addition of an emitter-follower inside the amplifier has some advantages. This is shown in Fig. 24, and is an example of the d.c. feedback-pair. Again the economy of components is a feature of the circuit.

Field-effect transistors

With the increasing availabilities and falling costs of field-effect transistors it is worth indicating their behaviour in such circuits. The first and obvious advantage they have is near-infinite input-impedance. For a.c. applications where the frequency is not too high this may offset their disadvantages. Bias-point stability is in general less good since the drift in gate-source voltage with temperature is a function of operating current and varies considerably between units of a specified type. This is because there are two distinct terms to the drift, one equivalent to the V_{be} drift in ordinary or bi-polar transistors, and the other the change in resistivity of the source-drain path. Matched pairs are now available with differential drifts to within $10\mu V \text{ deg C}^{-1}$ so allowing circuits such as that in Fig. 25 to be designed. Here the f.e.t.s are used as the long-tailed pair to realize high input impedance, but using bi-polar transistor where the equivalent g_m may be more important. Similarly a single f.e.t. may be used in a circuit similar to that of Fig. 8. This is shown in Fig. 26 and the output impedance is lowered because the g_m of the combination is greater than that of the f.e.t. alone. Fig. 27. There is one further property of the f.e.t. that is of interest. The two temperature-dependent terms can be shown to cancel when the gate-source bias is about 0.6V short of pinch-off. Alternatively by changing the operating current and accepting the resulting drift we can adjust the initial gate-source voltage to zero. Only transistors with a particular value of pinch-off can meet these conditions simultaneously and presumably the tight selection would lead to excessive cost.

No details have been given of high frequency performance. This would require a great deal more space. Another aspect of impedance transformation is the use of positive feedback under the control of the overall negative feedback. The technique is widely applied to cancel out, for example, the small but finite output resistance remaining after the

application of heavy shunt derived n.f.b. To be added to this list are those emitter followers in which the emitter resistor is modified, either by replacing it with a constant current source or by making the effective resistance a function of load current (as in the White Cathode follower). In summary we can say that the designer has no need to limit himself to the conventional emitter follower for impedance transformation. There are a very wide range of more complex circuits with particular advantages such as low d.c. drift, pulse capability etc. With such a choice we should be able to get away from the limiting approach that turns the mind automatically to the emitter follower just because the term is so closely associated with the problems to which it is but one possible solution.

REFERENCES:

1. Aidler, J., Transistor Circuits, Electronic Engineering, November 1965, pp.757-8 (Letters)
2. Good, E. F., Semi-stabilized d.c. Supply, *Wireless World*, March 1968. p.27 (Letters)
3. Fairchild, A. F., 12 20-W Audio Amplifier.
4. Williams, P., The Amplified Diode, *Design Electronics*, January 1968.

Position-sensitive particle detector

In certain nuclear scattering experiments it is necessary not only to count the number of particles emitted but to determine their spatial distribution. For this purpose Philips Research Laboratories (Netherlands) have developed a new kind of detector based on a "checkerboard" or matrix principle, providing 80 separate detection cells in a sensitive area of about 2cm^2 . This consists of a silicon monocrystal, circular and 0.3mm thick, with ten contact strips on the top surface, arranged at right angles to ten other contact strips on the bottom surface. The result is an array of 80 reverse-biased diodes of the surface-barrier type. When a charged particle falls on one of these detection cells it generates a fast pulse (25ns duration) in each of the two contact strips forming the cell, and from these the co-ordinates of the impact position can be determined. The energy loss of the particles can be obtained from the heights of the pulses detected and from this the particles can be identified. Such detectors are being used in an apparatus at the Institute for Nuclear Physics Research in Amsterdam, each detector being mounted on the end of a "telescope" carrying associated electronics. There are 64 of these telescopes distributed round the target from which the particles are emitted, covering a total solid angle of 0.4 steradian.

International Ships' Gear Exhibition

A short look at some of the equipment on show

A large percentage of the stands at this exhibition held recently at Olympia, London, were devoted to electronics in one form or another and some interesting equipment was to be seen. The trend towards navigation/instrumentation systems controlled by a central digital processor was in evidence, although this sort of approach seems to be applied more to monitoring systems of which many examples could be seen and of which the Decca ISIS 300 is representative.

Outputs of up to 60 transducers, or other signal sources, are connected to a remote scanning unit which is in turn connected via a single cable to a central processor. The central processor will handle the outputs of up to six remote scanning units and a maximum of 240 signal input sources. The processor is also coupled to a printer, audio/visual warning devices and, if desired, control 'action' channels. The output of each transducer or signal source is compared with predetermined limits and appropriate indication and control action is initiated.

Collision at sea is always a hazard and not only in bad weather as events of the past have shown. A new Marconi radar, called Predictor, should do much to alleviate the situation and perhaps shows the current course marine radar techniques are taking. The equipment employs a 40cm p.p.i. display housed in a compass stabilized mounting, in other words the tube rotates to maintain either ships' head-up or north-up as desired.

Four push-button selected modes of presentation are possible. The first of these, "Targets", provides the operator with a conventional relative motion display with a choice of ranges increasing in 2:1 steps from 0.375 to 24 nautical miles. Own ship's bearing is indicated by a continuous marker against an azimuth ring surrounding the display and a variable bearing marker, which appears as a dashed line, is also provided.

All the time the radar is in operation it stores the information presented on the display for a period of six minutes in an internal store that is continuously updated.

Pressing the "True Tracks" button causes the true track of every target to be displayed on the screen, after a period of ten seconds has elapsed, as a series of four dots. Each dot represents the position of the target as it was six, four and two minutes ago and as it is now. The distance between dots enables the speed of each target to be estimated and the order that the dots appear

shows the direction in which each target is travelling.

On pressing the "Relative Tracks" button the equipment solves the triangle of velocities for each target on the p.p.i. and this information is presented on the screen, after a period of ten seconds, as a series of four dots for each target as before. The collision situation can now be easily assessed by extrapolating each line of dots towards own ship's position at the screen centre, if they are heading in that direction.

A possible avoiding action course change is decided upon if a collision situation exists and own ship's proposed new bearing is set into the radar. On pressing the "Predicted Relative Tracks" button a new triangle of velocities problem is solved for each target, the fixed bearing marker shows present course, the variable bearing marker shows the proposed new course and a circle in the centre of the screen indicates the ship's turning area. From the new display any collision hazard that *would* exist if own ship made the proposed course change is immediately apparent and further changes can be made until a satisfactory solution is obtained.

The transmitter operates at 3.2cm and provides a peak output of 25kW; the only thermionic devices used are the c.r.t. and the magnetron.

Use is made of the U.S. Navy navigational satellite system in an equipment being marketed by the International Marine Radio Company which gives a position fix to within 0.1 of a nautical mile. There are at present five navigational satellites in orbit, one of these is faulty although it is operational some of the time, they are on a polar orbit at

an altitude of about 600 miles. Twice daily the U.S. Navy determines the exact orbit of each satellite using computer processed radar information and relays these details back to the satellites for storage. The satellites continuously transmit, on accurate and highly stable carriers at 150 and 400MHz, messages lasting two minutes describing the orbital parameters of the satellite and containing precise timing information. To enable the position of a vessel to be calculated the following facts have to be known; three computed satellite positions, accumulated doppler shift of the satellite signals over the three measurement periods, refractive index of the ionosphere, altitude, speed, course and a rough estimate of the vessels present position, and the local time. Details of the satellite position are being transmitted all the time so this factor is known. The use of two stable, coherently related, carriers enables the effect of changes in the refractive index of the ionosphere to be cancelled out because refraction error is inversely proportional, to a first order approximation, to frequency whilst doppler shift is a direct function of frequency.

In the system being discussed a dual receiver is coupled to a Digital Equipment Corporation's PDP8/S computer and a small teleprinter unit. The computer is tied up only during the time taken to obtain a fix and is free for other duties for the majority of the time. A fix can be taken only when a satellite is over the horizon when line of sight reception is possible. The frequency at which this occurs depends on the position of the vessel but once an hour at 30° latitude is typical.

Three new Cossor radio telephones were shown for the first time which are designed to meet the channelling and other requirements established at the World Administrative Radio Conference in December 1967. The smallest of these, type CC.400M6, provides communication on up to six simplex or duplex channels in the international v.h.f. maritime band (156-165MHz) and has a transmitter output of 12W. The models, CC.402M12 and CC.402M18 provide 20W output and operate on 12 or 18 channels.

Among the four new radio telephones announced by Redifon is the 99-channel v.h.f. type GR470. When used as a 99-channel equipment channel spacing is 25kHz, alternatively, 50 channels at 50kHz spacing can easily be obtained. Up to three pre-determined channels can be automatically monitored.



Marconi Predictor radar console which has four modes of presentation of navigational information.

The Fuel Cell

Some of the more important facts about fuel cells and a prediction of the trend of future developments

by G. Beardmore, B.Sc., Grad.I.E.E., Grad.I.Mech.E., Grad.R.Ae.Soc.

The fuel cell represents one of man's age-old dreams: a box with no moving parts, which silently transforms heat directly into electricity. It is interesting to note here that the human body represents a highly advanced form of fuel cell, though only part of the energy produced is electrical.

Essentially, a fuel cell represents the separation of positive and negative charges during a chemical reaction and is simply a continuous feed primary cell, the electrodes having a purely catalytic action, not being consumed but speeding up the reaction. Thus unlike a primary cell, the fuel comes from an external source. Theoretically, any oxidation-reduction reaction could form the basis of a fuel cell, but in practice, only certain ones prove to be suitable.

The first fuel cell was constructed by William Grove in 1839. This simply demonstrated that the electrolysis of water could be reversed on platinum electrodes and gave very little power output. By the beginning of the twentieth century, advances in thermodynamics and electrochemistry had clearly shown the theoretical possibilities of the fuel cell, and the following thirty years were marked by intense theoretical and experimental studies, resulting in the publishing of several hundred papers but no practical devices. This state of affairs can be explained by the remarkable advances made in internal combustion engines during the same period which discouraged industrial support of the fuel cell.

Since the war, a considerable amount of research has been carried out, both in Europe and the United States. One of the largest

teams is that of the A.S.E.A. in Sweden which is using the "Amox" system with cracked ammonia as a fuel. In England, important work has been done by Bacon and his associates at Cambridge, while in America the U.S. Army Signal Engineering Laboratories in New Jersey have published very many papers.

There have been several practical devices made but two are of special interest. During 1959, Bacon in England demonstrated a fork lift truck and an arc welder, both run by a 6kW fuel cell. About the same time, Dr. H. K. Ihrig in America displayed a 20 horsepower fuel cell tractor.

Advantages and disadvantages of fuel cells

The first and foremost advantage of the fuel cell is that of efficiency, since it can be shown that the energy output is theoretically higher than that of a source using a Carnot heat cycle. In fact, as can be seen from Fig.1, the fuel cell has the highest efficiency of any generating system so far produced.

Among other advantages are the absence of noise, fumes and, in some cases, heat, coupled with inherent reliability and ability to withstand high overloads. In contrast with the internal combustion engine, the fuel cell has its greatest efficiency at low load levels and consumes little or no fuel while idling, making it of particular interest to the motor industry. The power-to-weight and power-to-volume ratios for a fuel cell are considerably better than those of its rivals, especially over long periods of use, and a comparison is made in Fig. 2.

The modular construction and geometric simplicity of the fuel cell make it eminently suitable for mass production. Mechanical tolerances involved are quite large— $\pm \frac{1}{16}$ in many cases. All this, coupled with the almost complete absence of maintenance, should lead to great flexibility of power plant design, since by simple switching, any combination of voltage and current can instantly be obtained.

The principal limitation of the fuel cell at the present time is that the fuels and materials used are expensive and, as yet, difficult to obtain. This leads to various financial drawbacks.

The maximum useful work obtainable at a constant temperature and pressure from a fuel cell is equal to the change in free energy

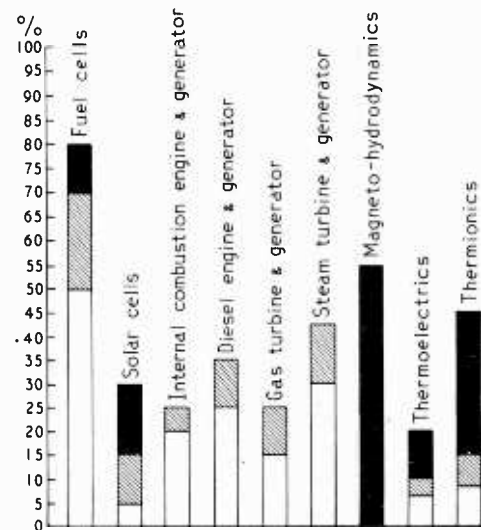
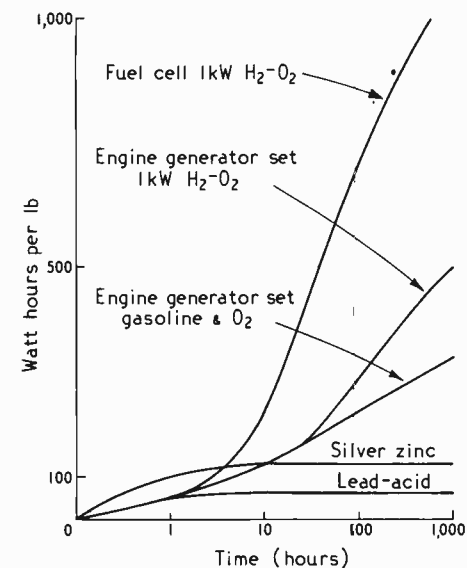

Fig.1. A table showing the percentage efficiency of energy converting devices and systems.

Fig.2. A graph illustrating power-to-weight ratios for different cells and power conversion systems.



G. Beardmore, who is 27, is working on the development of gas bearing gyroscopes with the Smiths Industries Aviation Division, Cheltenham. After leaving school he spent a year in the aviation industry and then went on to Manchester University where he gained an honours degree in Mechanical Engineering in 1964.

of the system, and the ideal fuel for such a cell should have—

- (a) A large free energy of oxidation;
- (b) A high rate of reaction.

There are also considerable advantages in having a fuel which is liquid at normal temperatures. Hydrogen satisfies both (a) and (b) but, being a gas, requires either a high storage pressure or a low storage temperature. Thus there is a growing tendency to turn away from gases and to look towards substances like hydrazine and related compounds as fuels.

The Bacon fuel cell

This will be described briefly as being a typical example. It should then be remembered that all other fuel cells are essentially variations on this principle.

The electrodes of the Bacon cell, illustrated in Fig. 3, are flat plates, 10in. dia. and $\frac{1}{16}$ in thick, formed from nickel by a sintering process which gives a fine pore layer on the electrolyte side (two microns) and a coarse pore layer on the gas side (twenty to thirty microns). Operating at a nominal temperature of 200 deg.C and a pressure of 400lb/in². (20,000N/m²) with a 35% aqueous solution of potassium hydroxide, the 40 cell unit develops 2.5kW at 32 volts, but can give 5kW at the sacrifice of some efficiency.

After initial preheating it maintains its own temperature. At the anode, hydrogen combines with the negatively charged hydroxyl ions in the electrolyte to form water, releasing at the same time electrons. At the cathode, oxygen combines with water and electrons. Hence electrons must move from anode to cathode through the electrolyte, and this will occur if an external connection is made between the electrodes. This connection is normally the load. The overall cell reaction is $2H_2 + O_2 \rightarrow 2H_2O$.

As previously stated, the efficiency depends on the current drawn and the following figures show the approximate magnitude of this variation.

Current density	Voltage	Efficiency
250mA/cm ²	0.8	65%
630mA/cm ²	0.6	50%

The longest revealed cell performance is 1500 hours at 200 deg.C with current density up to 400 amps/sq.ft. and a voltage of 0.68. In common with all other fuel cells, a rise in pressure or temperature will increase the output considerably. Finally, it is interesting to note that Professor F. T. Bacon is an engineer not an electrochemist, and says he built his cell "... using engineering principles".

Other fuel cell systems

Of the hundreds of systems that have been developed, the following are thought to be of most importance.

The Union Carbide cell is a H₂-O₂ this system using active carbon electrodes, consumed in the reaction, and concentrated potassium hydroxide electrolyte. It has been developed to a high performance level and can also run on CO and alcohol.

In Sweden, Olle Lindstrom and his companions at the A.S.E.A. Fuel Cell Department, Vasteras, are working on the "Quadrus" cell using cracked ammonia as a fuel. This has nickel and catalytic silver electrodes held in a plastic framework, with ducts for the gases and electrolyte, and has an output of 100 watts at 100mA/cm², 70 deg.C and one atmosphere pressure.

Considerable work has been done by M. I. Gillibrand and G. R. Lomax of the Chloride Electrical Storage Company, Swinton, Manchester, on a hydrazine fuel cell. The overall cell reaction is stated to be as follows,

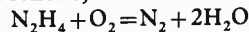

and polarization is decreased by increasing the flow of hydrazine. A particular feature of this cell is its neat construction and it has been described as "... a cell that one can imagine people buying". Fig. 4 shows the discharge characteristics of a hydrazine cell.

A nuclear regenerative cell has been successfully operated at the Union Carbide Research Laboratories, Parma, Ohio, using cobalt-60 gamma rays to decompose acidified ferrous sulphate solution to ferric sulphate and hydrogen, which are then re-combined in a fuel cell. However, the efficiency of such a system is severely limited by the relatively poor efficiencies which can be realized in radio-chemical decompositions.

Perhaps the greatest achievement is the cell developed by Doctors Willard T. Grubb and Leonard W. Niedrach at the General Electric Research Laboratory, Schenectady, New York. Their cell runs on diesel oil and air at 150 to 200 deg.C, the by-products being CO₂ and water. A 40 to 50% efficiency is obtained, but the phosphoric acid electrolyte and platinum catalyst make the cost very high.

Special military systems

A considerable number of fuel cell systems is being developed by the Aero-Jet General Corp., California, which, while they are uneconomic, have a very high power density and are specifically intended for military and space applications. Though much of this work is secret, it is known that they use consumable metal electrodes such as zinc or magnesium, and very reactive oxidants such as chlorine or 1-chloro, 1-nitropropane.

Design considerations

There are four main aspects to the design of fuel cells.

1. Structure (For high power density)
2. Reactivity (To achieve efficiency)
3. Density (For reliability and economy)
4. Stability (For long life)

In addition to these, the cell must be designed so that the transport of the material, and the second function, the electrochemical reaction itself, are promoted equally. The electrodes and electrolyte must be good conductors to maintain a continuous and adequate flow of current, and the cell should, if possible, work at atmospheric pressure and a reasonably low temperature,

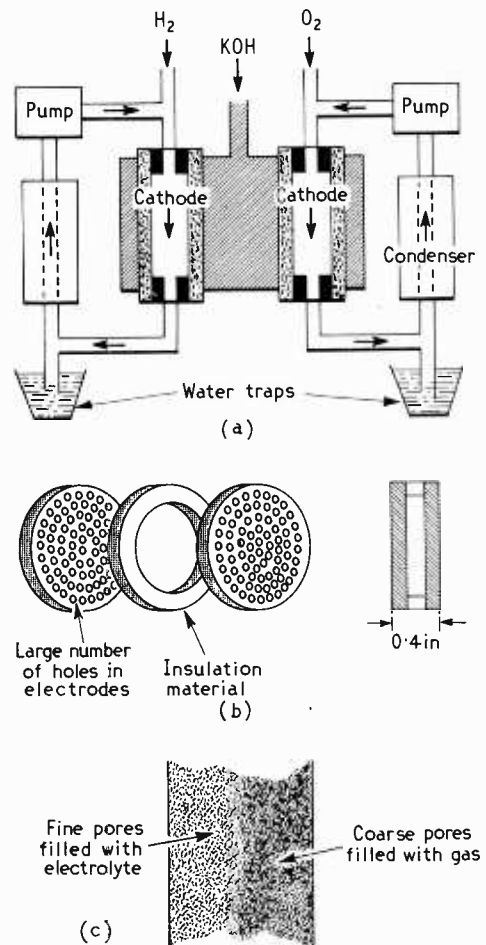

Fig.3. The Bacon Cell. (a) A schematic diagram of the cell showing the hydrogen and oxygen gas circulation routes. (b) A diagrammatic representation of electrode structure.

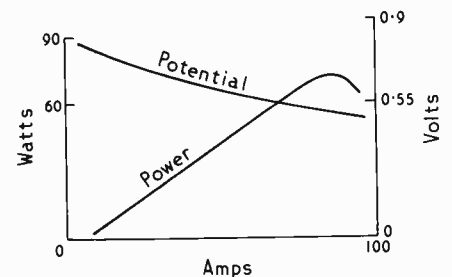

Fig.4. Discharge characteristics of a hydrazine fuel cell.

generating no noxious vapours. As with most engineering problems many of these considerations are contradictory and so fuel cell design is usually a succession of compromises.

Economic considerations

As previously pointed out, the cost is perhaps the greatest drawback to the widespread use of the fuel cell. At the moment, capital cost ranges from £7 to £70 per watt and is comparable with that of thermo-electric generation in some cases. This is expected to drop to £7 per kW in the not-too-distant future, according to A.S.E.A. However, running costs are very high and, in the case of the hydrazine cell previously described,

are quoted at £3 per kW hour. This compares very badly with the marginal value of 0.64 pence per kW hour for thermal power stations, but not too badly with the 20 to 30 shillings per kW hour for dry batteries, indicating that the fuel cell might first find acceptance as a portable unit rather than a stationary one.

Fuel supply and production

Hydrogen, by far the most common fuel used, is both difficult to obtain and expensive. Two main sources immediately spring to mind. First, it could be obtained by electrolysis where there is surplus hydro-electric power and transported under pressure to where it was to be used. Secondly, it could be cracked catalytically—a method in wide use at the present time. The Swedish "Amox" system cracks ammonia on palladium-silver catalytic membranes to give exceedingly pure hydrogen. The cracking process could be carried out within the cell itself but would require a high operating temperature. Attempts have been made to utilize coal dust and other cheap fuels, but without much success.

Future trends

Fuel cell design, it is said, has now reached the stage that the aircraft industry was in at the time of Bleriot. However true this may be, one thing is certain. The fuel cell has a bright future ahead of it and is long past the stage of being a laboratory curiosity. Apart from the long term power station goal, there is a short term goal of units, ranging from 100 watts to 100kW, needed for special applications. One such application is for small submarines with a cruising time of a month or less. Beyond this time, nuclear power becomes more attractive but below it, the fuel cell's efficiency represents a vast improvement on the 10 to 15% overall efficiency of ordinary submarine batteries. Another interesting application is for the internal power of space vehicles. The Bacon cell is being developed in the United States for the Apollo moon project, where it will also provide potable water as a by-product.

Certain specialized fuel cells employ highly reactive metal, such as magnesium, for electrodes. These are consumed in an electrolyte, releasing electrochemical energy. When spent, the electrodes and possibly the electrolyte are replaced, manually or automatically, to provide a fresh supply of power. This type of fuel cell may thus be likened in many ways to a conventional primary cell. Due to the nature of the electrodes, this type of cell is exceedingly expensive to operate. However, cells of this type can be made to give high outputs for short periods.

It is believed that recent work in the USA has concerned cells that can achieve limited reformation of their consumable electrode structure by chemical and/or thermal means. If this is so, these fuel cells must have a partial secondary cell action.

Several regenerative (Redox) cells have been made, notably by King's College, London, and General Electric of America, but in view of the difficulties encountered,

it is doubtful if this system will rival the more orthodox direct type of cell. Many fused electrolyte cells are being built but present indications show that NaOH is likely to be the most useful electrolyte. Because such cells are inactive at room temperature they can be regarded as reserve batteries which could lie idle for many years, and be activated by the application of heat.

Perhaps the most important parameter to be considered in any future cell research is that of current density, since this alone decides the use to which the cell can be put. At the present time, cells working at maximum efficiency with ordinary fuels do not normally exceed 30A/ft². Recent theoretical studies however, have shown that at least 125A/ft² will be needed for a commercial stationary cell and over 250A/ft² for a portable one. It is thought that future research work to improve cell performance to these levels will concentrate on the development of more efficient, cheap, easily obtainable catalysts, rather than actual cell design, though obviously many improvements here can be expected. Future cells will almost certainly make wider use of the many modern plastics available, such as p.t.f.e, and the technique of winding very light pressure vessels from glass fibre, now used in missiles, could surely be applied to solve one of the cell's major problems; storage of fuel.

Just when the fuel cell will make its first impact on the market is open to discussion, but when it does so it will serve to extend the present field of electrical storage and generation rather than replace it.

REFERENCES

1. F. T. Bacon and J. S. Forest, "Recent research in Great Britain on Fuel Cells", Paper 119, section K., 5th World Power Conference, Vienna 1956.
2. E. Gorin and H. L. Rech, "Fuel Cells", *Chem. Eng. Progress*, Vol. 55, pp. 51-58, 1959.
3. "Summary of work on gas fuel cells", Sondes Pate Research Institute Report, January 9th 1957.
4. "Quadrum Cell", *New Scientist*, May 16th 1963.
5. F. T. Bacon "Fuel Cells", *New Scientist*, August 27th 1959.
6. L. F. Austin, "Fuel Cells", *Scientific American*, Vol. 201, pp. 72-92, 1959.

Conferences and Exhibitions

Further details are obtainable from the addresses in parentheses

LONDON

- Sept. 9-13 Grosvenor House
International Broadcasting Convention
 (I.B.C., c/o I.E.E., Savoy Pl., London W.C.2)
- Sept. 30-Oct. 2 Savoy Place
Tropospheric Wave Propagation
 (I.E.E., Savoy Pl., London W.C.2)

BIRMINGHAM

- Sept. 16-20 The University
Machine Tool Design and Research
 (Dept. of Mechanical Eng., The University, P.O. Box 363, Birmingham 15)

BRIGHTON

- Sept. 24-26 Hotel Metropole
Power Sources Symposium
 (D. H. Collins, Joint Services Elec. Power Sources Committee, P.O. Box 136, Croydon, Surrey)

CAMBRIDGE

- Sept. 23-27 The University
Electronics Design
 (I.E.E., Savoy Pl., London, W.C.2)

CARDIFF

- Sept. 18 & 19 Inst. of Science & Technology
Electrical Properties of Polymers
 (I.P.P.S., 47 Belgrave Sq., London S.W.1)

FARNBOROUGH

- Sept. 16-22 R.A.E.
Electronics at Air Show
 (S.B.A.C., 29 King St., London S.W.1)

HARROGATE

- Sept. 20-22 Hotel Majestic
Northern Audio Fair
 (C. Rex-Hassan, 42 Manchester St., London W.1)

MANCHESTER

- Sept. 3-6 Inst. of Science & Technology
Solid State Devices
 (I.P.P.S., 47 Belgrave Sq., London S.W.1)
- Sept. 24-28 Belle Vue
Electronics, Instruments, Controls & Components Show
 (Inst. of Electronics, Shaw Rd., Rochdale, Lancs.)

NOTTINGHAM

- Sept. 11-13 The University
Noise in Electronic Devices
 (I.P.P.S., 47 Belgrave Sq., London S.W.1)

READING

- Sept. 23-25 The University
Nucleonic Instrumentation
 (I.E.E., Savoy Pl., London W.C.2)

SOUTHAMPTON

- Sept. 18-20 The University
Gas-filled Valves
 (I.P.P.S., 47 Belgrave Sq., London S.W.1)

OVERSEAS

- Aug. 30-Sept. 3 Düsseldorf
Hifi 68
 (NOWEA, 4 Düsseldorf 10, Postfach 10203)
- Sept. 1-8 Milan
Radio & Television Show and Electronic Components, Instruments & Accessories Show
 (A.N.I.E., Via Donizetti 30, Milan)
- Sept. 9-14 Basle
I.L.M.A.C., Int. Laboratory, Measurement & Automation Techniques in Chemistry
 (Schweizer Mustermesse, 4000 Basle 21)
- Sept. 10-13 Versailles
Nuclear Electronics
 (Colloque Nucléaire, Boite Postale 17, 78-Chatou)
- Sept. 12 & 13 Minneapolis
Solid State Sensors & Transducers
 (I.E.E.E., 345 E 47th St., N.Y. 10017)
- Sept. 14-23 Lyon
National Radio & Television Exhibition
 (Foire Int. de Lyon, Palais du Congrès, Lyon 6)
- Sept. 16-18 Warsaw
Laser Measurements
 (Dr. S. Hahn, Komitet Narodowy U.R.S.I., Swietokrzyska 21, Warsaw)
- Sept. 16-20 Hamburg
Microwave & Optical Generation & Amplification
 (MOGA 68, Burchardstrasse 19, D-2 Hamburg 1)
- Sept. 17-19 New York
Tube Techniques
 (I.E.E.E., 345 E 47th St., N.Y. 10017)
- Sept. 25-27 New York
Sonics & Ultrasonics
 (I.E.E.E., 345 E 47th St., N.Y. 10017)
- Sept. 27-Oct. 4 Copenhagen
Electronics, Automation & Instruments Fair
 (E.A.I., Julius Thomsens Plads 1, Kobenhavn V)

Letters to the Editor

The Editor does not necessarily endorse opinions expressed by his correspondents

High-input impedance amplifier circuits

With respect to the article in the July issue on high-input impedance amplifier circuits, your author appears to have fallen into a trap when reaching the subject of "reducing the shunting effect of transistor collector output resistance". While it is true to say that the effect of this component of the input resistance can be reduced by bootstrapping, it is not true to say that this can be done with a single stage. This is because with an h_{fe} of $\gg 1$, the emitter current variations also appear in the collector circuit, and therefore C_F in diagram 3(b) acts as an a.c. short circuit. It is a question not only of C_F feeding the emitter voltage to the collector, but also vice-versa, so that since the two source currents are virtually the same, they naturally cancel out to a large extent.

To verify that this was true, the circuit 4(a) was built, using a similar high-gain small signal silicon transistor. The performance without, and then with the $10\mu F$ C_F fitted was (1) no C_F , gain = 0.95, R_{in} 500k; (2) $C_F = 10\mu F$, gain = 0.11, $R_{in} = 95k$. As can be seen from the results, the effect of fitting C_F is just the opposite of that required, and its use effectively prevents the circuit from working. That is not to say that the technique of bootstrapping the collector is worthless—rather, that it cannot be applied over one stage as suggested. If the output is taken from a subsequent stage, such as circuit 4(c), there is no reason why the technique should not work, as the current fed via C_2 to the collector of T_1 is taken from T_2 emitter, and is therefore drawn from the supply through the collector of T_2 which is not connected to C_2 .

P. A. JOHNSON,
Farnborough, Hants.

Loudness control for a stereo system

May I make two brief observations on the technological side, and a comment on the aesthetic issue?

Mr. Lovelock, in his July article, criticises *a priori* the universal practice, even of the most reputable manufacturers, but revealingly admits at a late stage that he has never owned a commercially available amplifier. As regards matching of 'law' in ganged components, let us leave aside

his theoretically based quibbles and ask: Do you know anyone who *in practice* has to adjust the inter-channel balance every time he alters the volume level? I don't.

As regards reliability of carbon-track pots., of course we have all met prematurely noisy controls, and yet even equipment designed to the highest standards incorporates these components (the Quad unit even has the volume control, a ganged carbon pot., combined with the on-off switch!) without running into trouble even though equipment of this class lasts a very long time. The answer to this paradox, of course, is that you get noise when you make the slider carry d.c., as in cheap radio sets where the volume control is connected direct to the grid of the first audio amplifier and carries a tiny current arising from the bias circuit.

On the aesthetic issue, I offer the iconoclastic suggestion that user-operated tone controls (unless they be preset once for all for particular listening-room acoustics) are superfluous. Granted that we tend to listen to reproduced music at a level lower than the theoretically correct one, it is not a gross discrepancy we are here dealing with—not a move from the arena to the upper gallery of the R.A.H., a change so drastic that whole lines of the score become inaudible! We are considering, rather, a drop of up to, say, 10dB. Over such a range I believe that *when listening to music* (as distinct from taking part in audiometric testing on single tones), the 'mind's ear' amply compensates for frequency-dependent differential sensitivity of the physiological mechanism. I feel sure that the agreeableness of a recording or broadcast is dictated by (a) the sheer technological excellence, (b) the balance of instruments and/or voices, and (c) the amount and quality of reverberation, *to the exclusion of minor deviations from a level frequency/response graph*; and I confidently assert that any recording which noticeably requires frequency correction will turn out to be well below acceptable standard on one or more of the other counts which are *not* capable of correction by the listener, so why bother with fiddling about?

IAN LESLIE,
London N.10

Concerning the first point raised by Mr. Leslie, although I have never owned a

commercially available amplifier (and hence been subjected to the 'brainwashing' suggested in a previous letter), I have known several people who have. They have suffered from noise over the much used centre portion of the track, and have had to adjust balance control for 20dB adjustment of gain. I have myself owned an expensive stereo solid-state tape recorder which did not carry d.c. in the track, and one carbon control became unbearably noisy in six months, the second (on the other channel) after eleven months.

On the matter of tone-controls I agree with Mr. Leslie. I consider them to be a once-for-all adjustment for the characteristics of the room, and it is because I wish to leave them as pre-sets that I desired a compensating loudness control.

I would also agree with Mr. Leslie that for a variation of output of up to 10dB, there is no need for a compensated control. It is quite usual, however, to find two people who require the same programme reproduced in the same room at 20dB difference, and this is where one commences to get the R.A.H. effect mentioned.

Finally, I would question Mr. Leslie's policy of despair. Only a minority of recordings come up to the standards which he specifies, and I agree with him that they make one dissatisfied with all of the others. Since the normal person has to listen to recordings which are less than perfect for a proportion of his time, however, there seems no good reason why an attempt should not be made to minimize the aesthetic displeasure arising. He concludes "why bother with fiddling about?", and it was precisely to avoid the need for such frequent adjustment that an automatic compensation was designed.

R. T. LOVELOCK.

Mr. Lovelock has complained of the lack of matching in carbon gain controls and drawn upon himself the wrath of a component manufacturer.

Having been faced by a similar problem myself, I have devised a very simple method of improving the situation. If a resistor is connected from one end of a gain control to the moving contact, the characteristic will be altered. If the connection is made to the top of the control, the effect will be to raise the curve, and if it is made to the bottom the effect will be to lower it. The effect will be greatest at the end remote from that at which the connection is made, and of course the ends of the characteristic curve will stay put. With mismatched stereo gain controls, a resistor should be connected from the moving contact to the top of one control, and from the moving contact to the bottom of the other. This will raise the lower part of one curve and lower the upper part of the other curve. By proper choice of resistors, the curves can be brought into coincidence at two intermediate points, and the mismatch overall will be greatly reduced.

A side effect of the modification will be to make the end-to-end resistances of the controls non-constant, and the possible effects of this should be watched. Also, in calculating the values of the resistors

to be used, the shunting effects of the other components connected to the moving contacts should be borne in mind.

J. E. A. FISON
Harrogate, Yorks.

As I believe I was the first to throw the cat amongst the pigeons with my article on the fallacy of correction for scale distortion in the January, 1942 issue of *Wireless World*, perhaps you will allow me to comment briefly on the loudness control controversy.

To be technically logical and consistent the advocates of this control should boost the top as well as the bass at reduced volume levels. Instead, in the great majority of instances, the bass only is boosted, resulting in the listener hearing 'near' bass and 'distant' middle and top together at the quieter levels. This cannot by any means be natural reproduction nor high-fidelity. One is justified in assuming, therefore, that they are purely and simply lovers of plenty of bass.

In my article I gave the fixed bass boost circuit incorporated in my equipment to correct the deficiencies in the bass of the B.T.H.-R.K. loudspeaker I was using at the time. The B.B.C. has a more sophisticated circuit in the amplifier associated with their Monitor loudspeaker. It can be claimed that with such a fixed bass correction circuit, if the loudspeaker response renders it necessary, adequate and satisfying natural bass can be enjoyed at any volume level.

A. S. EVANS
Colchester, Essex.

Boosted Power Supply

The writer had a requirement for a voltage greater than that supplied by the standard power supplies of the system on which he was working. The standard voltages were +6, +12, -6 and -12 volts. To have installed an additional conventional power supply would have been costly and introduced wiring difficulties. What was required was +18 volts at 100μA for use in enabling a large swing to be obtained from a d.c. amplifier.

Referring to the accompanying diagram, a multivibrator (Tr_1, Tr_2) was used to drive a transistor to produce an 18-volt p-p square wave. This was clamped to +12 volts, rec-

tified (D_3, D_4), smoothed (C_3) and the output stabilized to +18 volts by means of ZD_1 (a 6-volt zener) which stands on the +12-volt rail.

A. SANDMAN
Harlow, Essex.

F.E.T. a misnomer?

Having read the letters from Messrs. Willis and Kershaw published in your July issue discrediting the term transistor, as applied to the f.e.t., I feel inclined to offer a defence of this nomenclature. The term 'transistor' or 'transfer resistor' does not imply that the device which it describes possesses one junction, two junctions, or an insulated gate; it does not, in fact, provide any information upon the structure of the device, but only concerning its most important property. A resistor may be looked upon as a device through which a current flows in accordance with the potential difference existing across its two terminals, similarly, a transistor may be defined as a device in which a current flow resulting (although admittedly according to an exponential law) from the potential difference between two electrodes (base and emitter) is transferred to the third electrode (the collector), while the base draws only a fraction of the total emitter current ($\frac{1}{1+\beta}$). In an ideal transistor one would expect no current to be drawn from the base whatsoever. The fact that bipolar and field-effect transistors work differently does not invalidate the term 'transistor' as applied to either (although one might apply the terms 'parallel field' and 'normal field' to the two devices respectively in accordance with their geometry). Concurrently, I would concede that the term 'unijunction transistor' is a misnomer, on the ground that the device is not a transfer resistor.

N. B. TAYLOR
Hove Sussex.

I must take issue with A. F. Willis concerning some remarks he made in a letter headed 'F.E.T. a misnomer?' in your July issue. Leaving aside the controversial question of the precise definition of 'transistor' I will confine my comments to paragraphs three and four of his letter.

'Again, by definition, the transistor is a current controlled device . . . ' By whose definition? The fact is, of course, that a bipolar

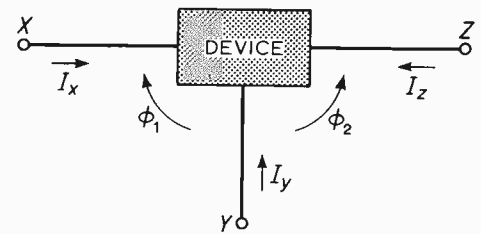

B. L. Hart's black box representation of a semiconductor device.

junction transistor may be modelled as a current controllable, voltage controllable, or charge controllable device. The 'best' model for a given application will depend on the nature of the problem. For example if the transistor is connected in a shunt-feedback amplifier configuration it might most suitably be considered as current controlled and the applicable model is the current controllable one. In switching circuits the charge model might well be the most suitable even though the drive might be a circuit-determined current.

Now to the question of g_m . If one adopts Mr. Willis's definition of a transistor it is not logically possible to define a transconductance—which expresses a voltage controlled current transfer relationship! In the diagram the black box represents either a field-effect device or a bipolar junction transistor.

For a transistor $X \equiv E, Y \equiv B, Z \equiv C$ and $I_x + I_y + I_z = 0$

For an f.e.t. $X \equiv S, Y \equiv G, Z \equiv D$ and $I_x + I_z = 0$ since $I_y = 0$ (sensibly) In terms of the terminal-pair voltages ϕ_1, ϕ_2 the following expressions for current may be written for d.c. operation:—

$$I_x = f(\phi_1, \phi_2) \dots \dots \dots (1)$$

$$I_y = g(\phi_1, \phi_2) \dots \dots \dots (2)$$

Let us concentrate on I_x . If the device is 'on' and biased to such a condition that,

$$\left(\frac{\partial I_x}{\partial \phi_1}\right)\phi_2 \gg \left(\frac{\partial I_x}{\partial \phi_2}\right)\phi_1 \dots \dots \dots (3)$$

Then (1) may be rewritten,

$$I_x \approx f(\phi_1) \dots \dots \dots (4)$$

In this case the definition of a ratio $(\partial I_x / \partial \phi_1) = g_m \neq f(\phi_2)$ has practical usefulness. If (3) is not valid then the device is best considered as a voltage controlled resistance and the concept of g_m loses much of its value. Thus to sum up, the 'g_m' for both bipolar transistor and f.e.t. is significantly only dependent on ϕ_1 , when the device is used in linear amplifier service. In passing it is instructive to note that a bipolar device has a g_m (proportional to I_E) fixed by nature, i.e. it is independent of device and technology. This fact has been exploited in the design of reproducible amplifiers. The g_m of an f.e.t. operated in the pinch-off region is proportional to $\sqrt{I_x}$ for a given device geometry, and is highly technology-dependent.

B. L. HART
West Ham College of Technology
London, E.15.

"Test Your Knowledge"

I welcome Mr. Ibbotson's series "Test Your Knowledge" as an interesting presentation of technical information.

Question 13 in Part 1 (June) asks for the

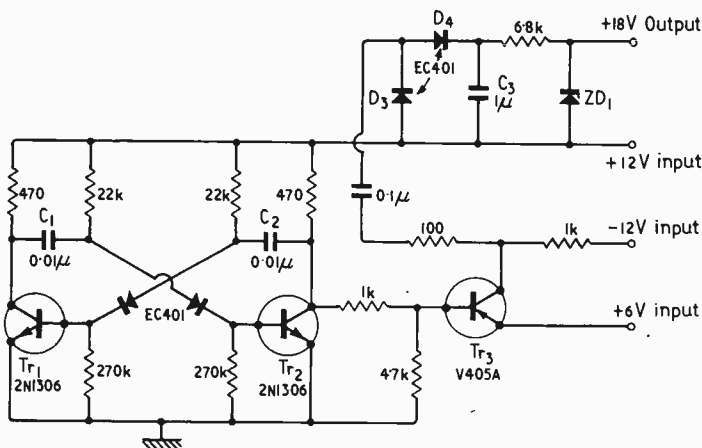

Multivibrator circuit proposed by A. Sandman for boosting a 6V or 12V supply to 18V.

definition of "turn-on voltage" (or "offset voltage") in an enhancement insulated gate field effect transistor (i.g.f.e.t.) I should like to comment that, when speaking of devices (rather than circuits), the terms "turn-on voltage" and "offset voltage" are not synonymous.

Turn-on voltage is fairly described by Mr. Ibbotson in answer (b) and it is often alternatively referred to as "gate threshold voltage". The turn-on voltage of a typical p-channel i.g.f.e.t. is about -5 volts.

The offset voltage of an f.e.t. is the source-drain voltage measured at very small source-drain currents. In the case of an i.g.f.e.t. with negligible gate-substrate leakage current the offset voltage is exceptionally small and has been quoted as "of the order of 10^{-14} volts for a switch at uniform temperature".

It is the negligible offset voltage that makes the i.g.f.e.t. so attractive as a low level chopper.
P. J. T. MELLOR
P.O. Research Department,
London, N.W.2.

The author replies:

In talking generally about m.o.s.ts one can conveniently use the term "gate offset voltage" since that term is suitable to describe the gate voltage at which drain current commences to flow in either depletion or enhancement mode devices (neither "turn on voltage" nor "threshold voltage" seem quite appropriate for a depletion mode device).

When I composed question 13 I overlooked the fact that "offset voltage" is used in the way that Mr. Mellor describes—particularly in connection with bipolar switching transistors for which its value can be significant.
L. IBBOTSON.

"In the beginning . . ."

It is proposed to make a half-hour film for BBC-2 about the beginnings of wireless. Could I possibly appeal through your journal for anyone with stories to tell of the early days of wireless (say pre-1925) to drop me a line with brief details?

MICHAEL RABIGER,
Documentary Programme Dept.
Room E.1022
BBC Television Centre,
London, W.1.

Electronic Music Studio Survey

I am conducting a survey of electronic music studios in Great Britain.

Perhaps some of your readers will know of studios either privately or collectively owned with which they could put me in touch. Some may even have their own equipment. In any case I would be grateful if they would contact me with any relevant information.

KEITH WINTER
Arts Council of Gt. Britain,
105 Piccadilly, London, W.1.

Letter from America

Tape and colour TV just about tied for top interest at last year's Consumers' Electronics Show sponsored by the Electronic Industries Association, but at this year's show, held in two of New York's plushiest hotels—the Americana and Hilton (as well as overflowing to the smaller Warwick nearby), there was no doubt that tape had jumped to first place. According to E.I.A. figures, magnetic tape equipment sales (of which tape cartridge products are now the major percentage) are expected to pass the \$500M mark by the end of the year. This probably represents a total of some five million units! The emphasis on tape was highlighted by a Tape Equipment Conference held at the beginning of the Show. At this meeting John Chamberlin, of G.E., had this to say: "The total tape industry business at this time is about half the radio business but I believe tape sales will continue to mount as tape is the medium for the young generation". The lack of standardization was stressed by Frank Stanton, of Playtape, who said that the various types (four-track cartridges, eight-track cartridges, one- and two-track cassettes etc.) were confusing to both retailer and customer. Motorola's Oscar Kusistor predicted a sales market of \$1000M by 1972 and he went on to say that the automobile tape player was still the mainstay of the stereo cartridge business.

Of the 150 or so exhibitors, no fewer than 55 were showing tape cassettes or cartridges and tape reproducing equipment. Although the cassette players are capable of surprisingly good sound, considering the limitations of $1\frac{7}{8}$ -in tape speed, they would satisfy few hi-fi enthusiasts, and so most of the top audio manufacturers are sticking to the conventional reel-to-reel machines. Nevertheless, the situation may well change quite soon; the advent of chromium dioxide tapes, improved recording methods and better playback mechanisms might well cause the cassette systems to supersede reel-to-reel players. Many firms are putting their faith in four- and eight-track cartridges at present mainly used in automobile players. As Norman Racusin, of R.C.A., has it "Tape cartridges appeal to the affluent, mobile, well educated male". So now you know. . .

How about prices? Well, a simple cassette player can be had for as little as \$20 (about £8 10s.) with an average around \$60 ranging up to \$300 or so for a stereo a.m./f.m. receiver with 8-track player. Automatic players with six cassettes were featured by Aiwa and Philips and I understand similar units will soon be produced by several other

makers. Sony were showing an automatic reel machine as well as a range of high-quality reel-to-reel recorders. One of the most interesting cassette players was demonstrated by Teac. This machine, which is beautifully styled, has two separate capstans and three heads and it can record and playback in both tape directions. Not only that, but it offers a choice of two tape speeds, $1\frac{7}{8}$ and $3\frac{3}{4}$ -in! Signal-to-noise ratio is quoted as -45dB and frequency response is stated to be 60 to 10,000Hz. The output is 0.5V and provision is made for 600-ohm and high-impedance microphones.

Colour TV was attracting a lot of interest and there were several noteworthy innovations. Sylvania were showing a 23-in model called the "Scanner Colour Slide Theatre". You can use it for showing colour slides on the tube screen and a built-in cassette tape recorder allows you to give a recorded commentary as well! On the tape 60Hz pulses are recorded to operate the slide changing mechanism and programmes of up to two hours can be arranged. The flying-spot scanner uses a 5-in tube and resolution is stated to be 40% better than normal colour TV.

Motorola had a very lavish presentation of their new line of "Quasar" TV. I am not certain what "Quasar" means in this context but the great feature seems to be accessibility and general design techniques to aid the service engineer. Module construction is used and they are all solid state—apart from the tube itself. A newly developed silicon high-voltage rectifier is featured and it is available with appropriate flyback transformer to replace the rectifier tube in older sets. These solid-state rectifiers have to operate reliably under extremely high voltages up to 35,000 p.i.v., with pulses of 7.5ms at 30,000 volts, and Motorola claim that the new device is far superior to the series-connected lower voltage types used up to now. Various small screen portable sets were to be seen including a 7-in model by Sony. Incidentally, diagonal tube measurements are usually quoted although some firms use the square-inch figure.

Almost every manufacturer seemed to be showing at least one compact stereo music system. Japanese firms were very prominent in this field and here it was evident that great pains had been taken with the presentation and styling. This was really superb and the Japanese are beating the Americans at their own game!

IN BRIEF: Koss were demonstrating electrostatic earphones and a 500-watt kit amplifier (not together!). Panasonic had a new mini TV set with 1.5-in screen and Admiral featured a new ultrasonic remote control unit for colour TV control. With this unit one can turn the set on or off, adjust colour intensity, change channels and adjust volume. Mastercraft were showing a Japanese-made home video recorder which will sell for \$695 (say £290) complete with camera and 12-in monitor. Unlike other units, this recorder uses ordinary audio tape instead of the more expensive video tape. Many other v.t.s were seen and it certainly looks as if such items will be an indispensable part of the "well-educated, affluent" American's home in the not-too-distant future.

G. W. TILLET

News of the Month

S.R.C. review

The Science Research Council in a recently published report reviews the current situation in optical and radio astronomy in Britain. A start is going to be made this year on the protracted three-mile steerable array of eight 40-ft dishes at Lords Bridge, Cambridge. Although design work on the proposed 400ft Mk V radio telescope for Jodrell Bank is to be continued construction has been deferred for the time being. It is expected that the repairs to the Chilbolton aerial will be completed by September of this year.

It is clear from the report that the ESRO satellite programme—or programme that was—will not be providing much in the way of the space platforms needed by British scientists: a good deal of present astronomical research has to be done outside the blanket formed by the earth's atmosphere. Iris (Esro II) is in orbit and continues to function satisfactorily, ESRO I is due to be launched later this year. The LAS (large astronomical satellite), HEOS A (highly eccentric orbit satellite) and the TD 1 and TD 2 satellites have all in turn been cancelled at meetings of the member nations. A concerted effort has been made to reinstate the TD projects preferably within the ESRO programme, if not, then as a special project to be financed by those member states, possibly eight out of the ten, who are prepared to participate. However, it seems probable that no decision will be taken for some months.

It is felt in some quarters that it is not beyond the bounds of possibility that Britain will pull out of ESRO at the end of the first agreed eight-year period in 1972 if ESRO continues to show small returns on a large capital investment in the way of space platforms, as opposed to sounding rockets. It could well be in these circumstances that Britain would go in with the Americans who have provided some generous assistance in the past.

Russian colour sets in London

Two of Russia's colour-television receiver range, described in the May issue of *Wireless World*, page 113, could be seen working in London at the U.S.S.R. Trade and Industrial Exhibition at Earls Court (Aug. 6–24). These were the Roubin-401 and the Radouga-5.

A hybrid chassis and a 59-cm diagonal 90° shadowmask tube are employed in both types, the tubes being Russian home-produced versions. Receivers with like specifications are sold in Russia at a fixed price, by agreement by a consortium of interested parties in the industry and the State. The Roubin-401 and the Radouga-5 sell at the equivalent of £550; the cheapest receiver is a 40-cm all-valve model, Record-101, at about £370. There is no government duty on consumer goods but the receiver price does include a levy, used to finance the broadcasting side (revenue is not collected by issuing a broadcast receiving licence). There are at present only two stations broadcasting colour-television programmes, one in Moscow and the other in Leningrad. At the Earls Court exhibition Tolchelnikov Nicolai of the Russian Ministry of Radio Industry, told *Wireless World* that the Moscow transmitter covers a service area of about 150km radius; the Leningrad station service is somewhat less. Only 6-7 hours of programmes per week are in colour of which some 60% are film. SECAM III is the system used, on v.h.f. This, asserted Mr. Nicolai, is the best system for fringe reception over the vast terrain which eventually has to be covered and also for video recording. It is planned for Russian viewers to see the Olympic Games in Mexico in colour via satellite, the signal being translated to SECAM in France and then relayed to the U.S.S.R. transmitters. Studio equipment is mainly of French origin but the Russians intend gradually to introduce equipment made in their own factories. Both 3-tube and 4-tube cameras are in use but their engineers seem to be biased slightly in favour of the 4-tube type. Russian officials at the exhibition were noncommittal on the number of colour receivers which had been sold in their country but it was clear that these amounted to only a few thousand.

Similar difficulties of supplying the industry with sufficient colour service technicians exist in their country as in the U.K. and training courses are in progress to give colour-service skills to technicians already trained in repairing black and white sets. Servicing is performed by separate service depots not attached to a sales organization.

We were led to believe that the Russian authorities are not completely satisfied with the reliability aspect nor the high cost of their receivers and they are at present working on the development of a second generation range of models which may feature the French

Chromatron tube. But this in turn depends on how successful are their efforts to iron out the problems associated with the Chromatron, particularly in finding a solution to the relatively high grid index power it requires. They do not envisage being in a position to manufacture an all-transistor chassis in the foreseeable future. At Earls Court, live colour pictures were originated in a small studio (3-tube camera) and relayed, at video frequency, by cable to the receivers.

Giant radio astronomy satellite

The 38th satellite in the American National Aeronautics and Space Administration's Explorer series was launched on July 4th from the Goddard Space Flight Centre. Explorer 38 (Radio Astronomy Satellite 'A') is designed to study l.f. signals from space that do not normally reach earth because of the reflecting action of the ionosphere. The space-craft has two V shaped aerials which may be extended or retracted by control signals from earth. When the aerials are fully extended they will form a huge 1,500-ft high 'X' in space. The upper aerial will monitor emissions from space and the lower aerial will simultaneously receive signals from earth so that cosmic radio signals can be separated from those emanating from earth. Another aerial, a 120-ft long dipole, will be extended to monitor l.f. signals from Jupiter and the Sun. Yet another variable length appendage will be extended to help damp oscillations of the space-craft caused by movement of the aerials and other forces. This stabilization boom is attached to a liberation damper system and will be extended to 630ft when the aerials are fully deployed.

Four television cameras will monitor the behaviour of the aerials during extension and will additionally be used to determine the source of radio signals received by the upper array.

The present state of the satellite, according to the latest reports from N.A.S.A., is that it has been successfully despun and is in a circular orbit at an altitude of 3,636 miles inclined 120.8° (59.2° retrograde) to the equator. The main aerial system was extended to a length of 455ft on July 22nd for initial measurements; all equipment is working normally. If all goes well the aerials will

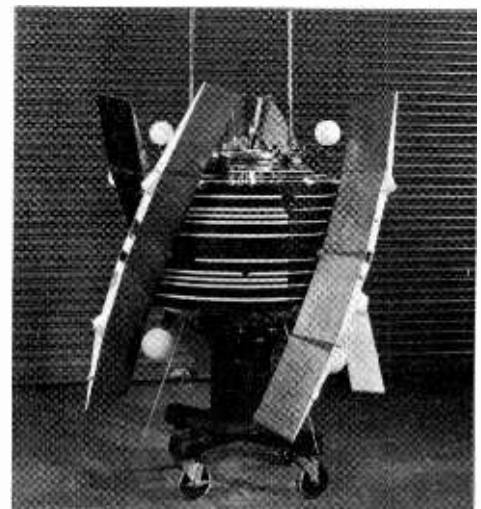

be deployed to the maximum length at a later date.

Four receivers in the satellite will receive signals from the aerials at nine spot frequencies between 450kHz and 9.2MHz. Two of these receivers measure signals from the two large V aerials, one receiver is coupled to the dipole and the fourth is a standby for the V aerial receivers. After every ten minutes of data reception the aerials are disconnected from the receivers and coupled to calibration equipment. The V aerials are connected to an impedance probe and the dipole to a capacitance probe for 30 seconds. This is done to measure the properties of the aerials to permit realistic evaluation of the received radio signals. In addition an electron trap measures the plasma environment of the space-craft. All this information is stored on tape and transmitted between 137 and 138MHz at 1.5W. Another transmitter operating between 136 and 137MHz is used for real-time data transmission and satellite tracking.

Northern Audio Fair

There will be about 40 exhibitors at this year's Northern Audio Fair to be held in the Majestic Hotel, Harrogate, Yorks, from Sept. 20 to 22. Admission is free, tickets (admitting two people) being available from equipment distributors, exhibitors and from *Wireless World*. We will send readers tickets on the receipt of a stamped addressed envelope.

Some well-known names in the audio field will not be seen at this exhibition. In a letter to *Wireless World* Mr. R. E. Cooke, managing director of KEF Electronics, writing on behalf of the "missing" companies (Armstrong, Goodmans, KEF, Lowther, Quad and Rogers), clarifies the situation.

"There seems to be some implication that British audio manufacturers are unwilling to support Northern dealers because many are not taking part in the Northern Audio Fair. This is by no means the intention. The International Audio Fair committee which fairly represents most British audio manufacturers held a meeting on February 20, 1968. It was pointed out that there were some 12 similar exhibitions in various parts of the world in which many of us have to participate, and it was for this reason that the committee elected by a majority vote to support only one Audio Fair in England each year."

Investing in technicians

The first results of the working party set up jointly by the United Kingdom Automation Council and the City and Guilds of London Institute in 1966 takes the form of a report, in booklet form called "Investing in Technicians". The working party first decided that it would be unnecessary and time wasting to define exactly what a technician is, a task that has bedevilled work in this field for many years, so a general broad definition has been adopted that inevitably leads to some blurring at the upper and lower limits.

The object of the booklet, and, of course, of the working party, has been to suggest courses for the following three groups of technicians:

(a) those pursuing initial training and education, (b) those already qualified in a discipline who wish to broaden their outlook for personal reasons or because of technical changes and (c) those already employed as technicians who have no formal qualifications but who may wish to acquire some.

The report recommends certain fundamental changes in the City and Guilds technician courses. These are aimed at improving flexibility both within and between courses and recognizing factors common to courses covering technician training in all branches of the industry. For those who wish to study the report in detail the booklet is available under its full title "UKAC Record No 9, March 1968—Investing in Technicians" from the Institution of Production Engineers, Publications Department, Chesterfield Street, Mayfair, London, W.1 at a cost of 5s.

U.K. transmitting licences

Over 100,000 radio transmitters for private two-way communication in the v.h.f. and u.h.f. bands are now licensed by the British Post Office. Three-quarters of the total are in use in vehicle control systems—taxi services, etc—and another 2,300 are for ship-to-shore communication. Lighthouses account for another 100 and aviation for 2,500. A few transmitters are in use by the blind and in teaching deaf children to speak. The remainder of the transmitters are used by the police and fire services.

This is, of course, not the whole story, there are 16,000 licensed radio amateurs, 14,000 holders of model radio control licenses and, at the lower end of the frequency spectrum, some 3,000 users of inductive paging systems.

Low-cost wind-finding radar

Following the earlier successful wind-finding radars, types W.F.1, W.F.2 and the higher performance W.F.44, which together are in use in 65 countries around the world, Plessey Radar have announced a new low-cost equipment designated type W.F.3. In announcing the new radar, Group Captain Fennessey, managing director of Plessey Electronics, made it known that the Australian Bureau of Meteorology had ordered five of the equipments at a cost of £50,000 following a three-month evaluation programme, Plessey claim that the radar, priced at £10,000, costs about half the amount of any comparable equipment obtainable anywhere.

The three-foot diameter Cassegrain aerial employed in the unit, together with the transmitter and receiver, are housed in a spherical radome which can, in one configuration, be supported on a tripod that also carries the necessary additional electronic equipment. If desired the sphere can be remotely situated from the rest of the equipment. Connection to the sphere is accomplished using cables, instead of slip-rings and brushes, limiting the aerial to two revolutions in azimuth. In the equipment's normal role this is not a disadvantage and the cost, reliability and servicing problems associated with slip-rings are eliminated.



In operation the radar tracks a balloon carrying some sort of radar reflector, typically a low-cost frame covered in aluminium foil, as it drifts off down wind. Digital indicators provide a readout of range, bearing and elevation enabling wind speed and direction at various altitudes to be calculated. The maximum range of the radar is 150km.

Tracking is accomplished by employing the conical scan method. The aerial sub-reflector is eccentrically mounted and made to rotate at 1500 r.p.m. causing the transmitted beam to describe a circle in space. Four reed relays actuated by a magnet on the reflector determine in which quadrant the balloon lies and operate the aerial drive motors accordingly.

Lidar illuminated

The possibilities of lidar, or light radar (light in the optical sense) were first explored some twenty years ago when radar systems using pulsed light were built. These, it was hoped, would escape enemy detection and provide higher definition. The projects were not successful because components with a high enough performance were not obtainable. The high-power lasers and sensitive photomultipliers now being produced have enabled lidars with high performance to be built.

A typical high-power ground radar transmitter would radiate about 10MW for a period of 5μs, roughly 50 joules per pulse and a typical microwave radar receiver will provide a usable output with an input around 10⁻¹⁴W. The output from a ruby laser suitable for use in a lidar system is of the order one to 100 joules and many photomultipliers will give a useful signal-to-noise ratio with input powers around 10⁻¹³W. A comparison that is more important, and gives the lidar a superior angular discrimination and results in more of the radiated power hitting the target, is the beamwidths of the two systems. The beam divergence of a typical radar is two degrees as against two milliradians for the laser system. Because of the shorter wavelengths used in the lidar system changes of the refractive index of the atmosphere can be detected that would be invisible to radar. These advantages of the optical system have been known for some time and the term lidar was first given to an optical radar in 1964.

A prototype lidar was built by G & E Bradley Ltd, transmitting a 50-joule pulse. This equipment obtained usable returns from targets with altitudes of up to 50km on clear dark nights. The nature of the target is not known but it could be meteorite dust or some other particles in suspension in the upper atmosphere. Very strong signals were obtained from the vapour trails of jet aircraft at slant ranges of 20km.

The prototype lidar is now being used by the Central Electricity Research Centre for studying the effluent of chimneys along the Thames estuary. Another lidar built by Bradleys along similar lines to the prototype just described has been installed at the experimental site of the Meteorological Office for cloud-base measurements. It will record cloud base from 15m to 3km and normally drives a pen recorder; however, if an oscilloscope is used, a detailed analysis may be made. Film records of a single trace have shown seven layers of cloud within the range of equipment, a definite advantage over the normal airfield optical triangulation method. Another advantage in this application is that it is not necessary to establish a base line so that the equipment could be used by a small vessel at sea.

A typical lidar system would comprise a Q-switched ruby-laser transmitter providing about 5 joules per pulse, the pulse width being in the region of 30ns, operating through an optical system with an exit aperture of 10cm. The receiver would be a telescope with a photomultiplier near the eyepiece. In the Bradley prototype system the telescope is a modified amateur astronomical telescope with a 20-cm objective. The output of the photo-multiplier is fed through a video amplifier and then to an oscilloscope on a range-measuring unit which drives a pen recorder. This is a flagrant simplification, however, the basic essentials have been outlined.

The lidar is now a practical instrument for tracking chimney effluent and other airborne aerosols and can provide information in this application not obtainable by any other means. Experimental use of lidar as a cloud-base recorder indicates that it can be a practical substitute for systems currently being employed. Before it is accepted as such, more work has to be done to make it suitable for remote, if not unattended, operation. Bradleys inform us that they have just completed a very high-power lidar intended for upper-atmosphere research by the Hebrew University, Jerusalem.

Amateur records cloud-cover pictures

Cloud-cover television pictures transmitted from the ESSA weather satellites have been received and recorded by M. Spas Delistoyanov, of Sofia, Bulgaria, using a home-constructed installation. Two different methods were employed, the first, using a 144MHz 5-element Yagi, retuned to 137.5MHz, which is rotated manually in such a way as to track the satellite and follow the rotation of its polarization simultaneously. The received signal is fed into a crystal-controlled converter coupled to a communications receiver and a tape re-

recorder. The receiver has an amplitude limiter and f.m. detector built in after its second i.f. The recorded 2400Hz sub-carrier, amplitude modulated by the video signal, is fed to an amplifier with an amplitude limiter. A local multivibrator operating at 2400Hz is synchronized with this limited signal. The 2400Hz signal is fed into several frequency dividers with a final output of 8Hz. A 4Hz signal is, in fact, necessary because the picture is transmitted at four lines per second—that is 800 lines per frame in 200 seconds. The 8Hz signals control a 4Hz phantastron (saw-tooth generator). The pulses from the phantastron are amplified by two transistors, collector of the second (power) transistor being connected to the horizontal scanning coil of the cathode-ray tube of a normal domestic TV set. A separate 200 seconds' phantastron, together with an identical two-stage transistor amplifier, provides the vertical scanning waveform. In order to minimize distortion the a.c. filament supply to the cathode ray tube is removed and replaced by d.c. A camera is placed, with its shutter continuously open, in front of the cathode ray tube and thus a picture is produced using normal photographic methods. The second technique is as follows: After synchronizing the 2400Hz multivibrator with the 2400Hz sub-carrier this frequency is applied to several frequency dividers until a frequency of 60Hz is obtained. The 60Hz signals are fed to a power amplifier which drives a small synchronous electric motor. The latter rotates a drum with a photographic paper placed around it. A video signal is supplied through an amplifier to a neon light-modulating tube—of the type used in photo-telegraphs. An optical system using a microscope focuses the light beam on the photographic paper. The picture is thus obtained directly, after the usual processing of the photographic paper.

The experiments were started in the latter half of April 1968 and numerous successful recordings of ESSA 2 and ESSA 6 were made up to the middle of June 1968. The second method provided far better picture quality.

5-kW Laser for i.c. production

Potential applications for a new Q-spoiled yttrium aluminium garnet laser from Union Carbide include trimming resistors and removing metal from integrated circuit substrates. The laser has an essentially diffraction-limited beam with a peak power output of more than 5kW at 1.6 microns and a repetition rate of between 800 and 1200 p.p.s. Holes as small as 2.5 microns in diameter can be produced repeatedly using the laser.

Baird travelling award

A 22-year-old electronics student, Antony Roma Taylor from the University College of North Wales, Bangor, has won this year's John Logie Baird travelling award. The £200 award is made annually by the Royal Television Society in conjunction with Radio Rentals and is given to a post-graduate student

in a U.K. educational establishment. Antony Taylor will travel to the U.S.A. to further his work in evaluating the potential of solid-state devices, which use plasma principles, to the field of electronics.

Jodrell Bank No. 1 aerial to be modified

The performance of the No. 1 aerial at Jodrell Bank will be improved following structural modifications that are to be carried out during a forthcoming repair programme. In the autumn of 1967, fatigue cracks appeared in part of the dish support structure and wear in the azimuth track became evident.

The Science Research Council will be footing the £400,000 bill for the repair and modification programme which is expected to take about two years.

TV Licence increases

The combined sound and television licence fee is to be increased from £5 to £6 and the sound and colour television licence from £10 to £11. The increases will be effective from January 1st, 1969.

Post office figures for the second quarter of 1968 show that the number of licences issued for colour television continue to rise at a rate of about 5,000 per month, the June total being 34,157. The monochrome and sound total is 15,188,329. Sound only licences, which remain at 25s totalled 2,546,628 including car radios.

More American peripherals to be made in Scotland

Optical character recognition units from I.B.M. will soon be manufactured at the I.B.M. plant in Greenock, Scotland, for delivery to all parts of the world with the exception of Canada and the U.S.A. The Scottish plant will produce two models that are currently being manufactured in America and three new models that have just been announced by I.B.M. This is in addition to the work already being carried out at Greenock on the 1130 computer, data and transmission systems, keypunch and verifying equipment and memory units.

Progress of Pro Electron

During the first months of this year, the number of manufacturers subscribing to the Pro Electron type numbering scheme increased to a total of 40. The Pro Electron system was described in *Wireless World*, February 1968 in an article "Transistor Rationalization" by T. D. Towers.

In Britain, Ferranti, Mullard and S.T.C. have registered both valves and semiconductor devices; E.E.V., R.C.A. and Thorn-A.E.I. have registered only valves, while SGS-Fairchild, Texas Instruments and Transitron have registered only semiconductors.

Personalities

Leslie H. Bedford, C.B.E., M.A., B.Sc., F.I.E.E., M.I.E.R.E., retired from the post of director of engineering of B.A.C.'s Guided Weapons Division on June 30th. Mr. Bedford joined the English Electric Company in 1947 and, in the following year, took charge of a guided weapons project which led to the formation of a G. W. Division of that company. With the formation of the British Aircraft Corporation he became director of engineering of its Guided Weapons Division. He will continue as a part-time consultant to B.A.C. with special reference to space and inertial navigation. Mr. Bedford is a graduate of both London and Cambridge universities and during the 1939/45 war worked on radar projects including the development of the first receivers for the "C.H." stations while with Cossors, of which he became director of research. His name is associated with the elevation attachment he produced for the early gun-laying radar equipment.

Laurie R. Fincham, B.Sc. (Eng.), has joined KEF Electronics as chief engineer. Mr. Fincham started his career as a graduate apprentice with Rediffusion and later joined Goodmans where he worked on loud-speaker design for several years. For the past four years he has been with Rola Celestion as chief engineer. **Malcolm Jones,** who has been with KEF Electronics since its formation in 1961, becomes senior development engineer.

L. R. Fincham



Michael Cox, B.Sc. (Eng.), has resigned as senior supervisory engineer in the Research and Development Department of ABC Television (which has become Thames Television) to devote time to consultancy and lecturing in the television field, and to more fully exploit the 'COXBOX' range of colour television caption equipment.



M. Cox

After graduating at University College, London, in 1957, he spent two years with Rediffusion before joining ABC Television. Mr. Cox has been retained by Thames Television to continue lecturing to staff as part of their colour television training programme, and as a consultant.

J. Evans, B.Sc., Ph.D., A.K.C. F.Inst.P., who joined Standard Telecommunication Laboratories, Harlow, Essex, in 1951, has been appointed assistant director of research, materials and components. Dr. Evans, who has worked in materials and components research since he joined the organization, was appointed research manager responsible for these areas in 1962. Separate divisions for components and for materials have now been formed and for the time being Dr. Evans will personally manage the Materials Division. **J. M. Coupland, M.A. (Oxon),** has joined S.T.L. to become head of the Components Division. For the past three

years he has been concerned with the co-ordination of valve development in the Department of Naval Physical Research, Ministry of Defence. He has been working particularly in the field of microwave receiving devices and lasers. He was at one time with the Services Electronics Research Laboratory at Baldock. At S.T.L. Mr. Coupland assumes responsibility for semiconductor devices, techniques for microelectronics, cold cathode emission and the synthesis of materials used in components.

Professor F. Graham Smith, M.A., Ph.D., of the Nuffield Radio Astronomy Laboratories, University of Manchester, has been appointed part-time deputy director of the Radio and Space Research Station at Slough, for two years from January 1st, 1969, in succession to **A. F. Wilkins, O.B.E.,** who is retiring. Professor Smith will be particularly concerned with the scientific programmes of the Station and his appointment is part of a continuing pattern of co-operation between the laboratories of the S.R.C. and the universities. Professor Smith, who is 45, graduated at Cambridge University where he subsequently worked for eighteen years with Professor (now Sir) Martin Ryle, F.R.S. He was appointed professor of radio astronomy at the University of Manchester in 1964. **Dr. F. Horner,** a senior principal scientific officer at the Station, has been appointed assistant director in charge of administration.

D. H. C. Scholes has become technical director of the Telecommunications Group of the Plessey Company which he joined in 1946. Mr. Scholes began his career as an engineer with Marconi and during the war served first at the Royal Aircraft Establishment, Farnborough, and later as a Lieutenant Commander in the Fleet Air Arm. He became chief radio engineer of Plesseys in 1950 and two years later, chief engineer of the Telecommunications Division. In 1960 Mr. Scholes was appointed chief engineer and deputy director of the Electronic and Equipment Group. He has been technical director on the central staff since 1965.

D. H. C. Scholes



Tom Mayer, B.Sc.(Eng.), F.I.E.E., manager of Marconi's Broadcasting Division for five years until his recent appointment as general ma-



I. G. Cressell

nager (components) in the company, has now been appointed managing director of the recently formed Marconi-Elliott Microelectronics Ltd, created by the amalgamation of the microcircuit interests of Marconi and Elliott Automation. The deputy managing director of the new company is **Ian G. Cressell, B.Sc., A.Inst. P., M.I.E.E.,** who joined the Marconi Company in 1950 as chief of the semiconductor physics group in the Research Laboratories at Great Baddow. Since 1964 he has been manager of Marconi's Microelectronics Division. Mr. Cressell, who is 50, joined the Air Ministry in 1940, after graduating, and was attached to R.A.F. No. 60 group (radar). In 1946 he joined the English Electric Company's Nelson Research Laboratories in Stafford.

G. N. S. Taylor is appointed sales manager (air traffic control) in the Marconi Company which he joined in 1949. He became deputy chief, responsible for civil radar in the Radar Division in 1958. He was for three years manager of the ATC Projects Group and was latterly product planning manager for the Division.

OBITUARY

Eric George Thorp Saunders, who died at his Oulton Broad, Suffolk, home on 23rd July, aged 49, was a lecturer at Walsall Technical College when, in 1942, he was directed to E. K. Cole Ltd., to work on the design and development of military communications equipment. In 1944 he returned to technical lecturing at the Cannock Mining College. He rejoined E. K. Cole Ltd. in 1950 and in 1956 was appointed chief engineer of Ediswan-Ekco (Aust.) Pty. On his return to this country in 1961 he took charge of the development of domestic television receivers for export. Since the merger of the E. K. Cole and Pye companies in 1966 Mr. Saunders had been at the Lowestoft laboratory of TV Manufacturing Ltd.

Constant-voltage D.C. Supplies

How to use semiconductors to obtain a fixed voltage output from a variable voltage source

by T.D. Towers*, M.B.E., M.A.

For much of your low-voltage circuit work, you can meet d.c. supply problems with a battery or a simple mains-operated power pack. The fact that the supply voltage may vary with the state of the battery or the mains voltage, and with the circuit loading is often unimportant. However, when you are dealing with circuits such as high-gain amplifiers that have exacting frequency, stability or output level requirements which can be adversely affected by variations in the d.c. supply voltage some kind of voltage-regulated supply becomes necessary. This article gives an account of the basic methods used to provide such supplies with semiconductors.

There are two main classes of d.c. voltage regulators, working on quite different principles: "linear" (dissipating) and "switched". In a linear regulator, a semiconductor operating in a linear region is interposed between the unregulated d.c. input and the load terminals, and operates to keep the output voltage constant. In a switched regulator, a semiconductor circuit between input and output is continuously switched on and off with a variable duty cycle to keep the mean d.c. output voltage constant. In this discussion, we will

* Newmarket Transistors Ltd., Newmarket, Cambs.

confine ourselves to linear regulators as they are more common and are much less complex.

Zener diode as constant voltage source

A zener diode can be used as a simple voltage stabilizer for many applications, particularly for supplying low current. Fig. 1(a) shows the basic arrangement in which the reverse-biased zener diode is fed from the unregulated input voltage, V_{IN} , through a series resistance, R_S . The zener selected has a breakdown voltage, V_Z , equal to the required output voltage, V_{OUT} . Ideally R_S is established by the formula

$$R_S = (V_{IN \text{ min}} - V_{OUT})/I_{\text{max}}$$

where I_{max} is the maximum d.c. load current required. Then, so long as the load current is less than I_{max} , V_{OUT} will remain constant at V_Z . Note that the sum of the load and zener diode currents remains constant.

In practical circuits under no-load conditions, the series resistor is selected to provide zener current of at least 5 to 10% more than the maximum specified load current as a safety margin. Thus R_S is chosen in practice as

$$0.9(V_{IN \text{ min}} - V_{OUT})/I_{\text{max}}$$

For good regulation, $V_{IN \text{ min}}$ should, if possible, be not less than $1.5 \times V_{OUT}$.

Having fixed R_S in Fig. 1(a), how do you select the necessary zener? Manufacturers provide zeners with a wide range of voltages and powers. Nowadays voltages are usually specified to a $\pm 5\%$ tolerance in what is known as the "E24 log series": namely 10, 11, 12, 13, 15, 16, 18, 20, 22, 24, 27, 30, 33, 36, 39, 43, 47, 51, 56, 62, 68, 75, 82 and 91. But manufacturers can also supply to other tolerances, such as 1%, 2%, 10%, 15%.

Available zener device dissipations are settling down conventionally to 400 mW (small glass or plastic DO7 JEDEC outline), 1.5 W (metal "top-hat" lead-mounted DO1), 10 W and 20 W (small screw-mounted stud DO4) and 75 W (large screw-mounted stud DO5). From about 6.8 V to 75 V, you can find a zener in any rating from 400 mW to 75 W fairly easily. For voltages below about 6.8 V down to the lowest common

value of 3.3 V, you are usually limited to 400 mW or 1.5 W devices. The following rule of thumb enables you to select the correct dissipation zener. Where V_{IN} can rise to a maximum of $V_{IN \text{ max}}$, the zener diode should have a dissipation rating of not less than

$$V_{OUT}(V_{IN \text{ max}} - V_{OUT})/R_S,$$

where

$$R_S = 0.9(V_{IN \text{ min}} - V_{OUT})/I_{\text{max}}$$

For example, for a 12 V, 1 A output with a minimum input voltage of 15 V, this gives $R_S = 2.7 \Omega$. If the input voltage can rise to say 18 V, the resultant maximum current through the resistance would be $(18 - 12)/2.7 = 2.2$ A. The resistor power rating would thus have to be not less than $2.2 \times 6 = 13.2$ W, and the zener rating (to cope with the condition of all the current passing through the zener under no-load conditions) not less than $12 \times 2.2 = 26.4$ W (calling for a 75 W zener, such as the BZY91/C12).

For a negative-output zener-stabilized d.c. supply, the circuit of Fig. 1(a) can merely be turned upside down. But the output earth would then be "floating", being separated from the input earth by the voltage drop across R_S . Where a common input and output earth is required, the zener itself can be inverted as shown in Fig. 1(b).

If you want a higher output voltage than you can get from a single available zener, you can stack any number in series as shown for two devices in Fig. 1(c). For each diode in the string, you must ensure that the zener used has the necessary dissipation rating, $V_Z \times I_{Z \text{ max}}$.

The Fig. 1(c) circuit can be used for another purpose too. Zener voltage is temperature-dependent. With zeners below about 5.5 V, output voltage falls with rise of temperature; above 5.5 V, output voltage rises with temperature. By selecting zeners of opposite temperature drifts and stringing them as in Fig. 1(c), you can achieve a composite zener with a low net temperature drift, should you require it.

In the basic circuit of Fig. 1(a), if the variation of V_{OUT} with V_{IN} is too much for your requirement, you can cascade zeners as shown in Fig. 1(d). Here, ZD_1 takes up the variation of input supply voltage and ZD_2 copes with variations in load current.

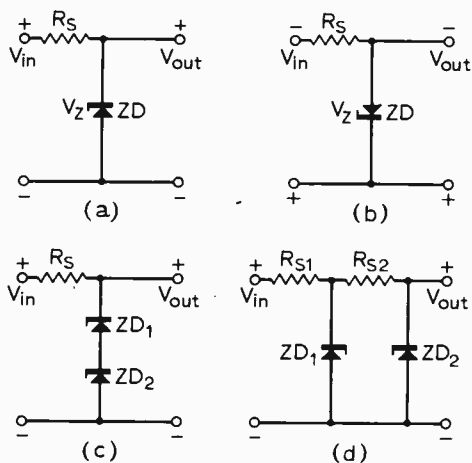

Fig. 1. Zener diodes as fixed voltage sources. (a) Single zener, positive output; (b) single zener, negative output; (c) cascaded zeners for higher voltage output; (d) feeding load zener, ZD_2 , from pre-regulated zener ZD_1 for greater output voltage stability.

Zeners used on their own for voltage regulation as in Fig. 1 have the great advantage of circuit simplicity, and cannot be overloaded by accidental short circuit of the output terminals. On the other hand, they are inefficient, for they take from the supply all the time the maximum load current, whatever the actual load current. Also, available voltages are restricted and, for high current requirements, zeners on their own can be expensive. For these reasons, a body of circuitry has grown up using transistors in combination with zeners to overcome some of the disadvantages of the zener on its own.

Transistor-aided zener diodes

When the load current in the simple zener-regulated d.c. supply of Fig. 1(a) above is more than can be handled by the zener diode you have available, you can cope with higher currents by adding a p-n-p shunt transistor as in Fig. 2(a) or an n-p-n transistor as in Fig. 2(b). In each case the output is closely clamped to the fixed zener diode voltage via the small V_{BE} of the transistor.

In Figs. 2(a) and (b) guide lines for the extension of the design of Fig. 1(a) are:

$$R_S = (V_{IN \text{ min}} - V_{OUT}) / (1.1 \times I_{\text{max}})$$

$$V_Z = V_{OUT} - V_{BE \text{ max}}$$

$$I_Z \text{ min} = 1.1 \times I_{B \text{ max}}$$

$$= 1.1 \times I_{\text{max}} / h_{fe \text{ min}}$$

$$R_B = V_{BE \text{ min}} / I_{B \text{ max}}$$

$$= 0.9 \times V_{BE \text{ min}} h_{fe \text{ min}} / I_{\text{max}}$$

The ratings of the resistors should be not less than

$$P_{RS} = 1.1(V_{IN \text{ max}} - V_{OUT})I_{\text{max}}$$

and

$$P_{RB} = V_{BE \text{ max}}^2 / R_B$$

The transistor should have a current rating at least twice I_{max} ; an avalanche voltage rating greater than V_{OUT} ; a current gain, h_{FE} , at $1.1 \times I_{\text{max}}$, not less than

$$1.1 \times I_{\text{max}} / I_Z$$

and a dissipation rating (on a suitable heatsink) not less than

$$1.1 \times V_{OUT} I_{\text{max}}$$

The transistor-aided zener d.c. voltage regulator of Fig. 2(a) or (b) has the inherent advantage of all shunt regulator circuits that it is intrinsically short-circuit-proof. Provided the series-pass resistor, R_S , has a power rating greater than

$$1.1 \times V_{IN \text{ max}}^2 / R_S$$

the circuit need not even be fused on the output side. It has the disadvantages that its regulation is less than perfect because of its relatively high output resistance, and also the output voltage can vary materially with

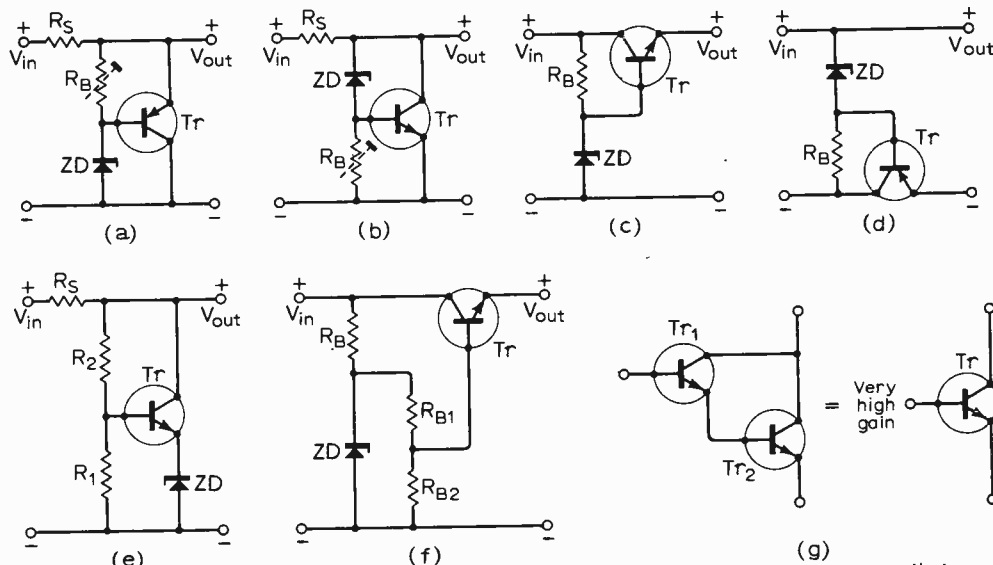

Fig. 2. Transistor-zener combinations to regulate at currents or voltages outside zener diode capabilities. (a) Shunt p-n-p transistor multiplies current load capability by transistor gain; (b) n-p-n transistor version of (a); (c) series p-n-p transistor current multiplier; (d) n-p-n version of (c); (e) shunt transistor increases output voltage to $(R_1 + R_2)V_Z/R_1$; (f) series transistor provides low output voltage; (g) common-collector transistor high-gain Darlington combination often used in practice.

temperature. Finally, it is inefficient because it draws full load current from the input supply all the time irrespective of the actual load current drawn.

A more efficient current multiplier arrangement is the series transistor-aided zener circuit of Fig. 2(c) for n-p-n transistors and Fig. 2(d) for p-n-p. Here again the output voltage is clamped to the zener diode voltage via the small V_{BE} of the transistor. Simplified approximate design formulae for this arrangement are:

$$V_Z = V_{OUT} + V_{BE \text{ max}}$$

$$I_Z \text{ min} = 1.1 \times I_{\text{max}} / h_{fe \text{ min}}$$

$$R_B = (V_{IN \text{ min}} - V_Z) / I_Z \text{ min}$$

R_B should have a dissipation rating of not less than

$$(V_{IN \text{ max}} - V_Z)^2 / R_B$$

The series-pass transistor should have a current rating not less than $2 \times I_{\text{max}}$; an avalanche voltage rating of at least $(V_{IN \text{ max}} - V_{OUT})$ at full load current (and, if load short circuit is possible, not less than $V_{IN \text{ max}}$); a power dissipation rating of at least

$$(V_{IN \text{ max}} - V_{OUT}) \times I_{\text{max}}$$

with a heat sink if necessary.

The series-transistor-aided d.c. regulator has the advantage of high efficiency, the current drain on the source being practically proportional to the load current. It has the defect that it is not intrinsically short-circuit-safe. Apart from a simple output fuse which is almost mandatory, practical versions almost always include some circuitry (often quite complex) to guard the series transistor against failure on overload.

When you want a regulated d.c. supply at a higher voltage than you have an available zener for, you can use a transistor as shown

in Fig. 2(e). For this, the regulated output voltage is given approximately by $(R_1 + R_2)V_Z/R_1$. The amplifying of the zener voltage is limited only by the voltage rating of the transistor.

In a similar fashion, if you want a controlled voltage lower than the available zener value you have, you can potentiometer-divide the zener voltage. In Fig. 2(f), the base of a series-pass power transistor, Tr , is strapped to the centre of a potentiometer, $R_{B1} - R_{B2}$, to give an output voltage,

$$V_{OUT} = R_{B2}V_Z / (R_{B1} + R_{B2}) - V_{BE}$$

And finally, in all the circuits of Figs. 2(a)-(f), the equivalent of a very-high-gain transistor can be obtained by replacing the single transistor with the common-collector Darlington-pair as shown in Fig. 2(g). This use of a compound transistor will be seen to be common in practical d.c. voltage regulator circuits illustrated later. The driver transistor, Tr_1 , provides most of the current gain and the main transistor, Tr_2 , most of the current and power requirements.

Practical transistor-aided zener voltage d.c. regulators

In Fig. 3(a) you will find a practical shunt transistor-aided zener circuit derived from the basic circuit of Fig. 2(b). The design shown can provide a regulated 20 V at up to 0.5 A from a 40-55 V d.c. input supply. The TO66-cased intermediate-power silicon transistor, Tr_2 , should be mounted on a heat sink with a thermal resistance of better than 2°C/W . A common type of heat sink is a flat square plate of aluminium. With this you can get down to 2°C/W in a 6×6 in. plate, $\frac{1}{8}$ in. thick (10 gauge), assuming natural convection, vertical mounting and matt black paint finish.

In Fig. 3(b) you will find a practical example of the series transistor-aided circuit

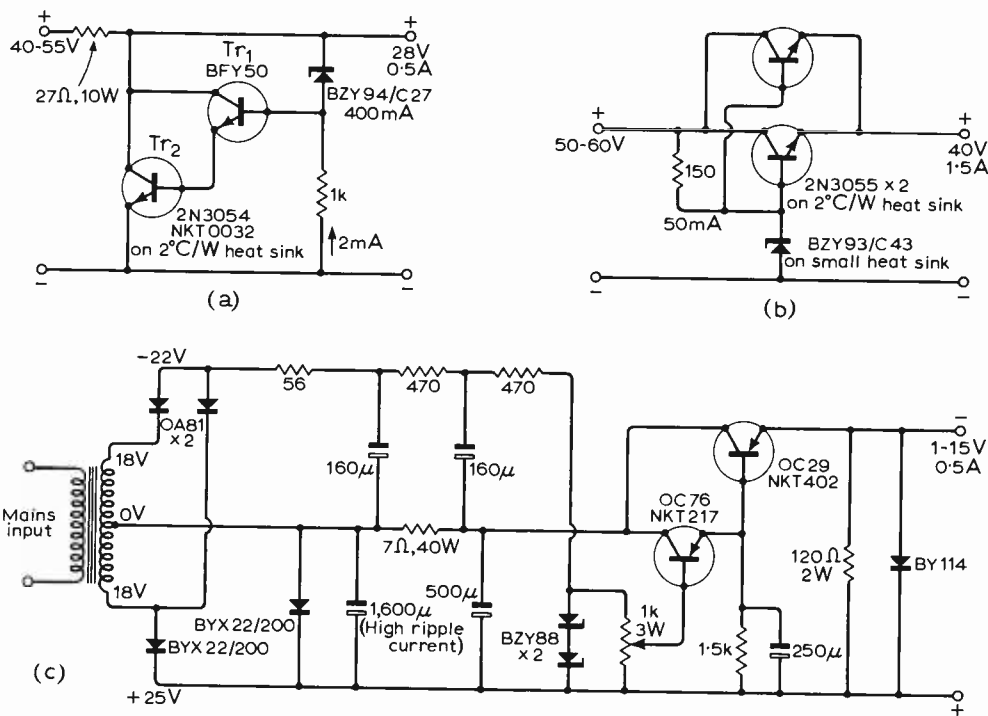

Fig. 3. Practical examples of transistor-aided zener-stabilized d.c. power supplies. (a) Simple shunt-regulated, 28 V, 0.5 A output from 40/55 V input; (b) simple series-regulated, 40 V, 1.5 A output from 50/60 V input; (c) variable 1-15 V, 0.5 A general purpose bench power supply (Mullard).

based on Fig. 2(c), and giving a regulated output of up to 1.5 A at 40 V. It features two 2N3055 silicon power transistors in parallel as series-pass elements sharing the load current and power dissipation, and mounted on suitable 2°C/W heat sinks.

Fig. 3(c) shows one further series-transistor-aided zener circuit in the form of a complete lab. bench power supply, able to provide from 1-13 V at up to 0.5 A (derived from a circuit published by Mullard Ltd.). Refinements on the basic circuit are: the Darlington pair used in the series-pass transistor arrangement; a separate smoothed d.c. supply to the zener diodes which considerably reduces the ripple on the output line; the 7 Ω current-limiting resistor in the collector circuit of the transistor; the variation of the reference (and hence the output) voltage by the 1 kΩ potentiometer across the zener; the 120 Ω bleeder resistor across the output; and the BY114 reverse-biased rectifier diode across the output to prevent transistor damage by accidental reverse positive voltage applied across the output rail from the load side.

Shunt d.c. voltage regulators with feedback

Transistor-aided zener d.c. regulators described so far are essentially "brute force" circuits which merely strap the output to a voltage close to the zener controlling voltage. However, the output voltage can be held much more stable by introducing some form of d.c. feedback comparison loop to improve the control. Most practical regulated d.c. power supplies use such a system.

In Fig. 4(a) the basic system for a shunt feedback regulator is illustrated in block schematic form. The output voltage is is

sampled in (A) and compared in (C) with a reference voltage (B). Any difference signal is amplified in (D) and applied to the shunt control element (E). This then adjusts the current through the series resistor, R_S (F) to keep the output voltage constant.

With transistors, the system of Fig. 4(a) could be realized in a circuit such as Fig. 4(b), where a fraction of the output voltage is selected by the potentiometer, RV (A), and applied to the base of the transistor, Tr_3 (C). The emitter of Tr_3 is connected to the zener diode, ZD , reference voltage (B). The difference between these two voltages controls the collector current in the transistor, Tr_2 (C), which is applied to the Darlington-pair transistors, Tr_2 (D), and Tr_1 (E). The current in the shunt transistor (E) is therefore controlled by the output voltage. The feedback loop thus operates to keep the output voltage constant.

Series voltage regulation with feedback

Feedback-controlled regulation has been illustrated in Fig. 4 with shunt control, but in practice series feedback regulation is much more common. The basic system for this is outlined in Fig. 5(a) in block form. Here the output voltage is sampled by (A), compared in (C) with the reference voltage (B), and the difference signal controls the amplifier (D) to drive a series control element (E). The series pass element keeps the output voltage constant irrespective of changes in input voltage or of output load changes.

To illustrate the principles, Fig. 5(b) gives one form in which transistors are used for series feedback regulation. (In this case, actual component values are given as the

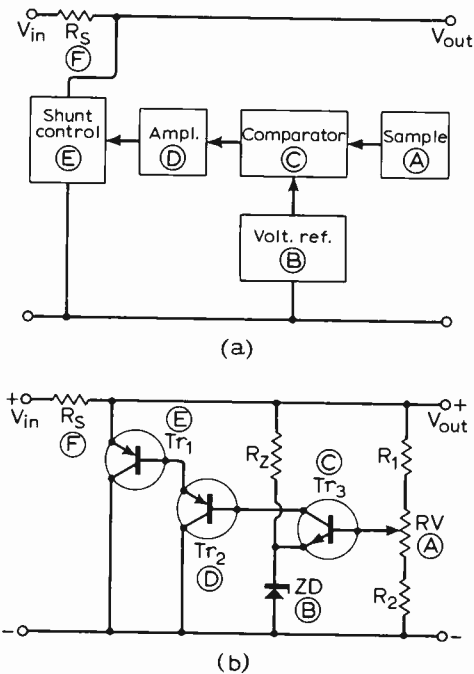

Fig. 4. Shunt voltage regulator with feedback control. (a) Basic system in block form; (b) the circuit diagram corresponding to the basic system

circuit is a useful practical one.) In operation the 30 Ω potentiometer (A) selects a sample of the output voltage and compares it with the zener diode, ZD , voltage reference (B) through the transistor, Tr_3 (C). The collector current of Tr_3 is controlled by the difference between the output voltage

Fig. 5. Series d.c. voltage regulator with feedback control. (a) Basic system; (b) transistor version of (a) with illustrative component values.

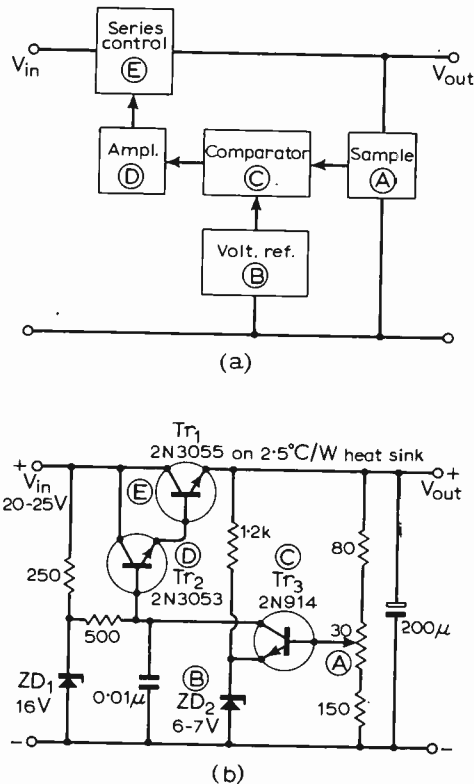
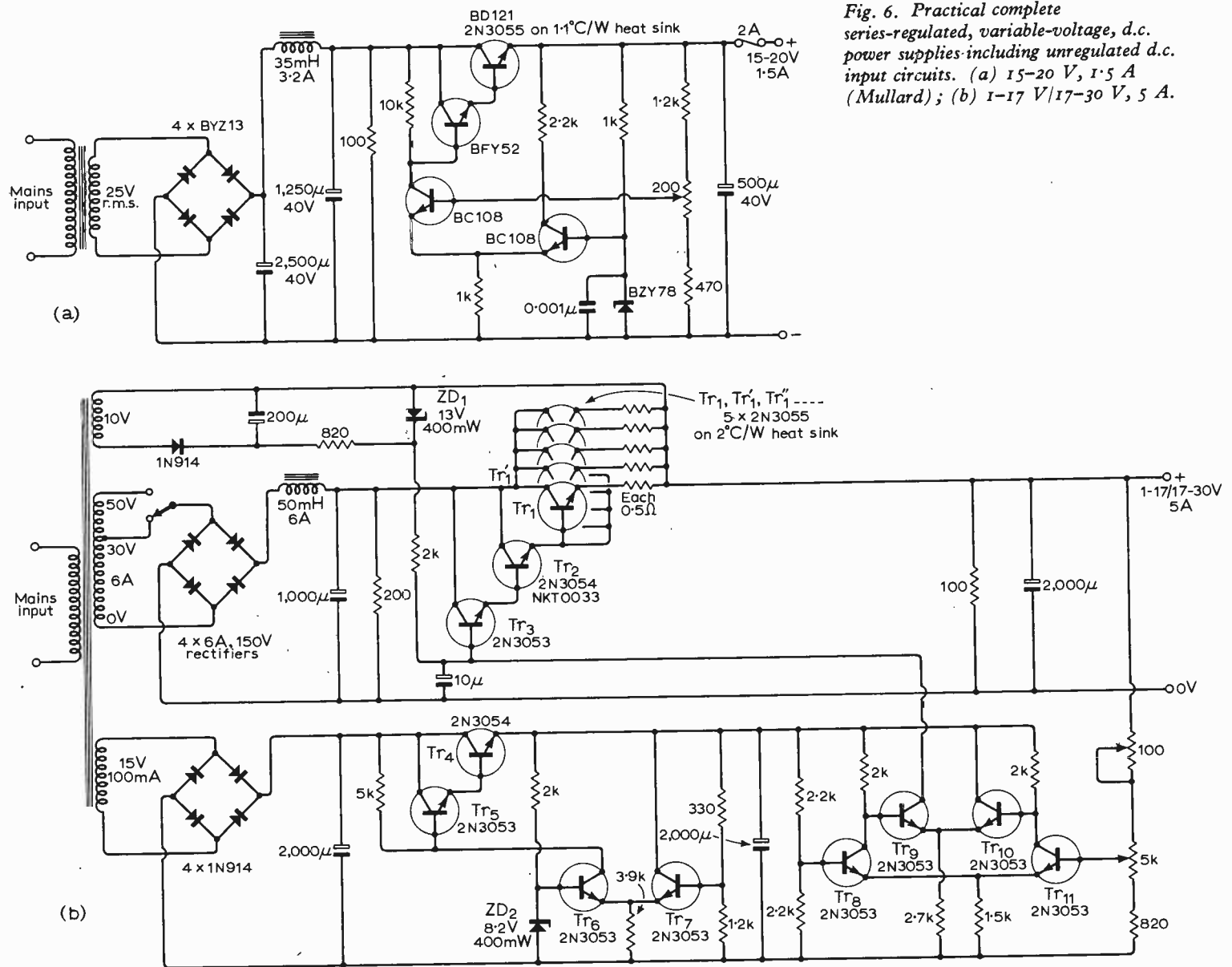

Fig. 6. Practical complete series-regulated, variable-voltage, d.c. power supplies including unregulated d.c. input circuits. (a) 15-20 V, 1.5 A (Mullard); (b) 1-17 V/17-30 V, 5 A.



sample and the reference voltage. The collector current of Tr_3 and the base drive current of the transistor Tr_2 (D) are both supplied through a 500Ω resistance from a 16 V zener, which is supplied in turn through a 250Ω resistance from the input voltage. Thus the sum of the base current of Tr_2 and the collector current of Tr_3 is constant. As the output voltage tends to rise, the base-emitter voltage of Tr_3 rises and its collector current also rises. The result is that the base current of Tr_2 falls. This means that in turn the collector current of the series-pass transistor Tr_3 falls. Thus there is produced a form of negative feedback to reduce the output voltage to compensate for the initial tendency to rise. The capacitors shown are conventional. The $200 \mu\text{F}$ across the output serves to smooth any ripple from the input. The $0.01 \mu\text{F}$ from the collector of Tr_3 to earth cuts the gain of the feedback loop at high frequency and prevents spurious circuit oscillation. The 80Ω , 150Ω , plus 30Ω potentiometer across the output provides a steady small bleeder current which prevents undue variation of output at light load currents. This is an example of the fairly common rule of thumb to provide always in series-

regulated d.c. supplies a standing bleeder current from the output at no load of around 5% of the maximum load current. The circuit as shown can be preset by the potentiometer (A) to precisely 12 V output, and provides a regulated voltage up to 1 A current over a temperature range of -20°C to $+70^\circ\text{C}$.

Practical series-with-feedback voltage d.c. regulators

As practical examples of feedback series-regulated d.c. supplies, Fig. 6 gives two complete mains-drive, variable output designs.

In Fig. 6(a) (a Mullard design), a preset output from $15\text{--}20 \text{ V}$ at up to 1.5 A is obtainable. The unregulated input d.c. supply is conventionally provided by rectification and smoothing combined with a 100Ω bleeder resistor to keep down the variation of the input voltage with load current. In the regulator part of the circuit, a long-tailed balanced transistor pair is used to compare the sample feedback voltage applied to the base of one transistor with the zener reference voltage applied to the other

base. This arrangement offsets the variation with temperature of the base-emitter voltage drops of the two transistors, and reduces the output voltage variation with temperature. The left-hand BC108 drives the BFY52-2N3055 Darlington-connected series-pass pair to control the output voltage. To obtain the low thermal resistance of 1.1°C/W specified for the heat sink, it is necessary to use some form of finned assembly, since it is impracticable to reach this low figure with a simple square or rectangular plate of aluminium.

Fig. 6(b) shows a more ambitious circuit capable of delivering up to 5 A regulated over two ranges $1\text{--}17 \text{ V}$ and $17\text{--}30 \text{ V}$. In this case, the series-pass transistor comprises five paralleled power transistors, Tr_1, Tr_1', \dots , mounted on 2°C/W heat-sinks, driven by a double Darlington pair, Tr_2, Tr_3 . The circuitry at the bottom of the diagram provides a regulated negative voltage supply for the comparison long-tailed pair circuit connected to the $5 \text{ k}\Omega$ potentiometer across the output. The feedback control collector current of Tr_9 , and the base drive current of Tr_3 are both provided through a $2 \text{ k}\Omega$ resistance from a zener diode, ZD_1 , tied above the output voltage

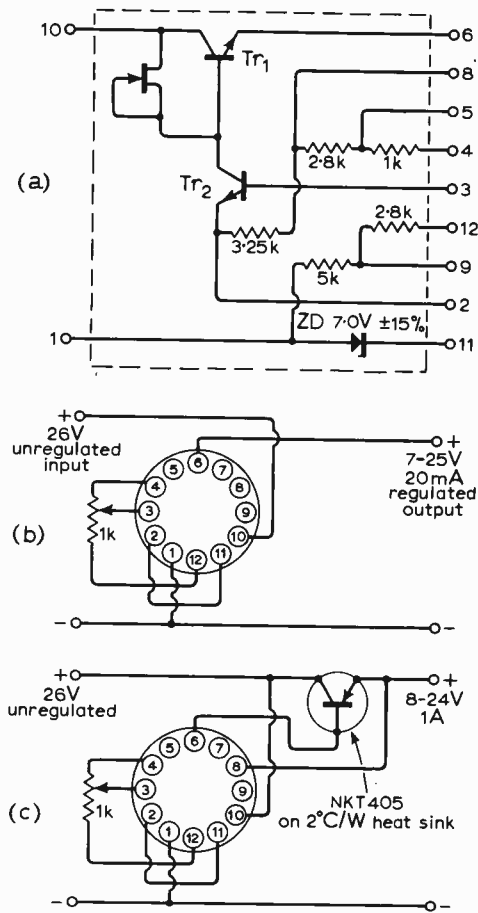

Fig. 7. Thin-film, hybrid integrated circuit d.c. regulator (Akers UH2019). (a) basic circuit; (b) connection as self-contained 7-25 V, 20 mA regulator; (c) connection as 6-24 V, 1 A regulator with external series-pass transistor.

rail by means of a separate d.c. supply in what is known as a pre-regulator circuit. The two output voltage ranges, 1-17 V and 17-30 V, are obtained by switching 30 and 50 V tapping on the secondary winding of the mains transformer.

Microcircuit linear d.c. voltage regulators

Commercial linear d.c. voltage regulator microcircuits are currently available in thin-film-hybrid, thick-film-hybrid or monolithic integrated circuit form. The internal circuits are developments of the circuits described earlier but adapted to the special form of microcircuit fabrication.

Fig. 7(a) shows the circuit of one example of a thin-film hybrid linear regulator, the Akers Electronics UH2019, packaged in a 12-lead TO5-style can. On its own, this is capable of giving a regulated output voltage from 7 to 25 V at up to 20 mA, from a 26 V unregulated d.c. input when connected up as shown in Fig. 7(b). You will see that it is a

fairly simple series-with-feedback regulator, with one unusual feature. The n-channel f.e.t., Tr₄, with source strapped to drain is a constant-current source that isolates the comparison and feedback control circuit from the input. For larger current handling, an external power transistor can be added as in Fig. 7(c) to produce a 6-24 V output at up to 1 A regulated.

In Fig. 8(a) we have the basic circuit of one thick-film hybrid version of a d.c. voltage regulator, the Beckman Instruments Helipot 806. This comes in a $1 \times \frac{1}{2} \times \frac{1}{8}$ in package with five terminal pins. It is fabricated with thick-film resistors and capacitors on an alumina substrate, with chip semiconductors bonded directly to the substrate. Short-circuit proof and fully sealed, it provides an output externally adjustable from 3 to 9 V with a load handling capacity of 3.6 W at room temperature in free air at up to 0.5 load current limit. If you trace out the circuit, you will see that it is basically a series-with-feedback regulator, with a special circuit, Tr₁₁, for sensing the output current and automatically limiting it under overload. Fig. 8(b) gives a typical use of the microcircuit on its own to provide a 6 V regulated output at up to 400 mA current. By suitable modification of the 7.150-4.320 kΩ output sensing potentiometer you can set the output voltage anywhere between 3 and 9 V. Connected as in Fig. 8(c) with an external transistor on a suitable heatsink, the regulator can give up to 5 A current over the same voltage range.

When you come to monolithic versions of d.c. regulators with all the circuitry diffused in a single chip of silicon, you find that the internal circuitry still follows the basic lines set out earlier in this article. However, it becomes very much more complex in points of detail because of the restraints imposed by the present state of the art of monolithic assembly; so much so that it cannot be covered adequately in this treatment. One example of such a monolithic regulator is the National Semiconductors LM100/200/300, available in an eight-lead, low-profile, TO5, hermetically-sealed encapsulation or in an equivalent epoxy version. This microcircuit can be used as a linear or a switched regulator, and its detailed circuitry will be covered in a later article dealing with that type.

This treatment of linear d.c. voltage regulators, insofar as it has dealt with principles and existing discrete-component circuit techniques, bids fair to become merely a historical state-of-the-art account, because current microcircuit developments indicate that within a few years units will be inexpensively commercially readily available off the shelf that will make it uneconomic to design and build discrete-component d.c. voltage regulator circuits.

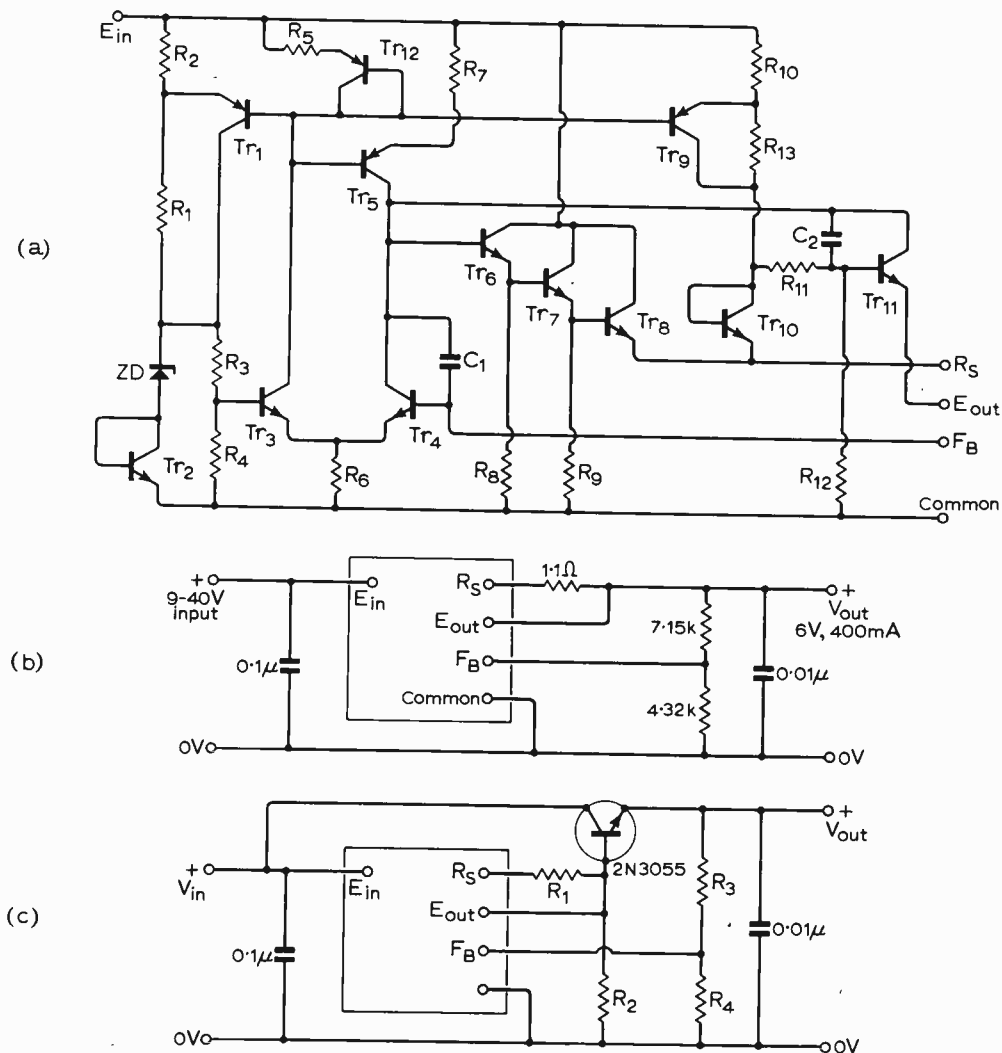

Fig. 8. Thick-film hybrid microcircuit d.c. voltage regulator (Beckman "Helipot" 806). (a) internal circuit; (b) connection for 6 V, 400 mA output; (c) connection for 3-9 V, 5 A output with external current multiplier transistor

Announcements

The 1968-69 Autumn term "Bulletin of Special Courses" in higher technology, management studies and commerce, to be held in London and the Home Counties, is now available from the Regional Advisory Council, Tavistock House South, Tavistock Square, London, W.C.1, price 9s.

The Council for National Academic Awards has issued a revised list of courses leading to its degrees. Copies of the 10-page booklet are obtainable from the Council at 3 Devonshire Street, London, W.1.

A 55-page prospectus giving details of courses to be held during 1968 and 1969 at the Northern Polytechnic, Holloway, London, N.7, is now available.

A post-graduate evening course on "Integrated circuit application theory" begins at West Ham College of Technology, Romford Road, London, E.15, on October 17th. Also arranged by the college, a specialist evening course on "Medical electronics" at the Medical College of the London Hospital, Whitechapel, London, E.1, beginning October 2nd.

Full-time courses in radio and television servicing and electronics servicing, will take place at the West Kent College of Further Education, commencing September 16th. Further details may be obtained from the Registrar, West Kent College of Further Education, St. John's Road, Tunbridge Wells, Kent.

Hounslow Education Committee are organizing a number of courses closely related to the study of radio. A radio amateurs' course and a Morse code course will begin in late September and a course on the mathematics of radio at the beginning of November. Details from F. H. Scotchmoor, Adult Education Office, Bulstrode School, Holloway Street, Hounslow, Middx.

Courses in preparation for the Radio Amateur Examination will be held at:—Corbridge County School, commencing mid-September, details from V. Allison, 14 Silverdale Drive, Winlaton, Co. Durham; Adult Education Centre, 28 Beckenham Road, Beckenham, Kent, commencing September 26th, details from M. D. Bass, 42 Clevedon Road, London, S.E.20; Bradford Technical College, Great Horton Road, Bradford 7, commencing September 23rd, registration at the College from September 9th to 13th; and Ainsty Institute of Further Education, Stockwell Road, Knaresborough, Yorks, commencing September 23rd.

A radio and television course will be held at the Wesley Evening Institute, Wesley Road, London, N.W.10, commencing September 23rd. Further details from D. E. Martin, 44 Worcester Crescent, Mill Hill, London, N.W.7.

A.P.A.E. Northern Show. The Association of Public Address Engineers is holding an exhibition and symposium in the Woodlands Hotel, Timperley, Cheshire, on Sunday, September 8th from 11.00 to 18.00. Admission is free; further details from the A.P.A.E., 394 Northolt Road, South Harrow, Middx.

Since May 10th the electronic component section of A. H. Hunt (Capacitors) Ltd, have become part of Erie Electronics Ltd., and all orders and enquiries relating to these products will be dealt with by the sales department at Erie Electronics Limited, South Dunes, Great Yarmouth, Norfolk. Hunts will primarily be concerned with the manufacture of power factor improvement capacitors.

Rocke International, of New York, have opened their own U.K. office at Tetra Pak House, Orchard Road, Richmond, Surrey. All quotations for the U.K., with the exception of some industrial products, will now be dealt with by Rocke International (U.K.) Ltd. from this office.

Elliott Electronic Tubes Ltd. and Marconi Instruments Ltd. have jointly announced that the responsibility for the future exploitation of Elliott precision microwave instrument and component designs is transferred to M.I.-Sanders, Stevenage.

Racal Instruments Ltd., of Crowthorne, Berkshire, have signed an agreement to market in the U.K. the products of Dynamic System Electronics, of Arizona, U.S.A. The American company manufacture high-speed multi-channel, low-level, data acquisition and data conversion systems for ground support and airborne use.

A substantial contract has been placed by the Ministry of Technology with Marconi Instruments Ltd., for the establishment of a 'Holding Unit' for the repair, calibration, and exchange of the many thousands of electronic measuring instruments supplied by English Electric companies, including Marconi Instruments, to the Royal Air Force.

Audio and Design Ltd., 40 Queen Street, Maidenhead, Berkshire, can now offer technical assistance by specialist engineers, on problems associated with, vibration, audio, acoustics etc.

An agreement has been concluded between the Decca Navigator Company, London, and Bombrini Parodi-Delfino S.p.a., of Italy, to establish a jointly owned company known as Sicon-Decca Srl. The new joint company will primarily be concerned with the establishment of the Decca Navigator System in Italy for both marine and air application.

Cressall Printed Circuits Ltd., of Sutton Coldfield, a member of the Expanet Group, have concluded an agreement with the Photocircuits Corporation, of Glen Cove, U.S.A., enabling them to manufacture under licence to the American company's patents.

Pioneer Designs Ltd., Crown House, 2-4 Church Street, Walton-on-Thames, Surrey, have taken over the printed circuit company Flexible Circuits Ltd., of Havant, Hants. The company will operate under the new name Pioneer Circuits Ltd.

Marconi recently signed a £1½ million contract for a tropospheric scatter communications system to link Belgium, Germany and Italy.

T. J. Sas & Son Ltd., of Victoria House, Vernon Place, London W.C.1, have announced that they are now able to supply capacitors manufactured by Baugatz, of West Germany.

Lorlin Electronic Co. Ltd., of Billingshurst, Sussex, have been appointed sole U.K. agents for the American 'Janco' range of rotary switches.

Improved and increased training facilities at Edwards High Vacuum Ltd., mean that, from July this year, more places will be available to companies who want to familiarize personnel with vacuum equipment and practice. Application forms and training programmes from the Customer Training Officer, Edwards High Vacuum Ltd., Manor Royal, Crawley, Sussex.

Ferranti—Grundig Agreement. The Numerical Control Division of Ferranti, Dalkeith, Scotland, and Grundig Werke, GmbH, West Germany, are to collaborate in the field of numerical control machine tool equipment and measuring devices. The agreement provides for the marketing and servicing of the products of both companies throughout the world.

Domestic Receivers

Individual trade exhibitions of radio and television receivers being held in London in late August number over 50 and most of these will be dispersed in 14 West End hotels.

All the exhibitions which are listed below will be open from Sunday, 25th August, to Thursday, 29th August, unless stated otherwise. A survey of technical points of interest and a pictorial selection of new items seen at the shows will appear in the October issue.

Acme Electric Co. (Finsbury) Ltd., Cafe Royal.

B. Adler & Sons (Radio) Ltd., (Eagle Products), Kensington Palace Hotel.

A.E.G. (Gt. Britain) Ltd. (Telefunken), Royal Lancaster Hotel.

Aiwa Co. Ltd., Royal Garden Hotel (24-29 August).

Alba Radio & TV Ltd., Cafe Royal.

Antiference Ltd., Kensington Palace Hotel.

Baird TV Distributors, Rembrandt Hotel.

Bang & Olufsen UK Sales Division, 70-71 Welbeck Street, W.1.

BMB (Sales) Ltd., Cafe Royal (24-29 August).

Bosch Ltd., Cafe Royal.

British Radio Corporation (Ferguson, H.M.V. Ultra), Royal Garden Hotel; (Marconiphone), Cafe Royal.

Crown Radio Co., Ltd., Kensington Palace Hotel.

Daltrade Ltd., Cafe Royal.

Dansette Products Ltd., Kensington Palace Hotel (24-29 August).

Decca Radio & TV, Kensington Palace Hotel.

Denham & Morley, Kensington Palace Hotel.

Discatron Ltd., Royal Garden Hotel.

Dynatron Radio Ltd., De Vere Hotel.

East West, 70-72 Old Street, E.C.1.

Elizabethan Electronics Ltd. (Dulci), Royal Garden Hotel (24-29 August).

Elsworthy Electronics, Kensington Palace Hotel.

Euromon (Radio & TV) Ltd., 174, Pentonville Road, London, N.1.

Fidelity Radio Ltd., Kensington Palace Hotel.

G.E.C. (Radio & TV) Ltd. (Masteradio, McMichael, Sobell), Carlton Tower Hotel.

Grundig (Gt. Britain) Ltd., Hilton Hotel.

Hacker Radio Ltd., Prince of Wales Hotel.

Highgate Acoustics, Piccadilly Hotel.

J Beam Aerials Ltd., Kensington Palace Hotel.

Kingsway Mills, Prince of Wales Hotel.

Lee Products Ltd. (Elpico and Hitachi), Royal Garden Hotel (24-29 August).

Lugton & Co. Ltd., Cafe Royal

Luxitone (Luxor), Piccadilly Hotel.

Mordaunt-Short Ltd., Prince of Wales Hotel (24-29 August).

Perdio Products Ltd., Kensington Palace Hotel (24-29 August).

Perry & Pharo Ltd., De Vere Hotel.

Philco International Ltd., Cafe Royal.

Philips Electronic & Associated Industries Ltd. (Philips and Stella), Royal Lancaster Hotel.

Pye Group (Ferranti, Invicta, Ekco), Europa Hotel.

Radon Industrial Electronics Co. Ltd., Mount Royal Hotel.

Rank Bush Murphy, Royal Lancaster Hotel.

Sanyo, Prince of Wales Hotel (24-30 August).

Sharp Sales & Service, Kensington Palace Hotel.

Sinclair Radionics Ltd., Europa Hotel (25-30 August).

Sony (UK) Ltd., Milestone Hotel.

S.T.C. Ltd. (KB and RGD), Hilton Hotel (25-30 August).

John Street (Manufacturers) Ltd. (Falcon), Cafe Royal.

Teleng Ltd., Kensington Close Hotel (28-29 August).

Telerection Ltd., Rembrandt Hotel.

Teleton Electro (UK) Co. Ltd. (Mitsubishi), Royal Garden Hotel.

Tellux, De Vere Hotel.

Unamec Ltd., Playboy Club.

Wyndors Recording Co., Kings Arms, Chelsea (28-29 August).

Low-cost High-quality Loudspeaker

2. Using the loudspeaker: Determining the electro-mechanical constants of the drive unit

by P. J. Baxandall, B.Sc. (Eng.), F.I.E.E., F.I.E.R.E.

An amplifier capable of giving a sine-wave mean output power* of about 10 W into a 15- Ω resistance load is quite sufficient for operating the low-cost loudspeaker. The use of higher output levels will give gross distortion and may cause permanent damage to the loudspeaker.

Measurements on the loudspeaker (described later in the article) yield an efficiency figure of about 1%, so that a 10-W amplifier is capable of producing from the loudspeaker a sine-wave mean acoustic power output of about 100 mW. From reference 8, this would be expected to give, in an average living room of, say, 1,500 cu ft, a sound intensity nearly 100 dB up on the standard reference level of 2×10^{-5} newton/sq metre r.m.s. This is about the intensity experienced in a good seat in a concert hall during very loud climaxes of orchestral music, though many musical people choose to listen at considerably lower levels at home. (An independent check with a microphone of known sensitivity, at 1 metre on axis out of doors, also gave an intensity of about 100 dB up on 2×10^{-5} N/m² for full output from a 10-W amplifier.)

Comparison in the author's living room of the measured sound intensity of a grand piano, and of the reproduction of a recording of this piano via the low-cost loudspeaker, showed that the loudspeaker, when driven by a 10-W amplifier (not overloaded), could produce an intensity very nearly, but not quite, equal to that of the piano itself when played at extreme fortissimo.

As mentioned earlier, the use of a woofer is really well worth while, adding depth and warmth to the reproduction, improving the naturalness of the balance and reducing listening fatigue.

In a mono system, the simple arrangement shown in Fig. 8 has been found very satisfactory, provided the woofer sensitivity is

* The author does not like the term "r.m.s. output power", despite its almost universal use nowadays. The product of r.m.s. voltage and r.m.s. current is not r.m.s. power, but *mean* power.



Peter J. Baxandall held an amateur radio licence (2AZS) while at King's College School, Wimbledon, but became increasingly fascinated by the problems of low-distortion sound reproduction, electrical musical instruments, etc. He obtained his degree in electrical power engineering at Cardiff Technical College in 1942, later becoming a radio instructor in the Hankey Radio Training Course there. He moved in 1944 to T.R.E. (now R.R.E.), Malvern, and worked on microwave techniques for the first two years before joining F. C. Williams's team on electronic circuit research work. He has latterly co-operated with industry in developing transistor power amplifiers.

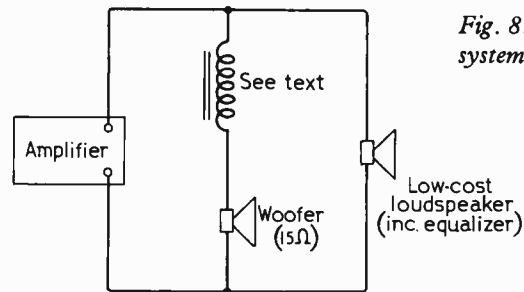

Fig. 8. Mono loudspeaker system with woofer.

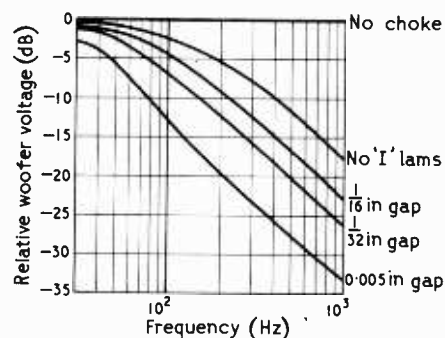

Fig. 9. Variation of woofer voltage with frequency for various choke gaps.

high enough. A suitable recipe for the choke is as follows:

Core, bobbin and shroud. Belclere Kit LX, in Silcor (1¼-in. stack of 0.014-in. laminations, Inter-Service No. 417, maximum dimension 2¼ in.).

Winding. 300 turns of 24 s.w.g. enam.

The choke gaps may be adjusted, using cardboard or other insulating material, to vary the output of the woofer, and Fig. 9 shows the effect of so doing on the voltage across a 15- Ω woofer mounted on a baffle board. The best setting may be determined subjectively.

In a stereo system, the simplest arrangement is to feed a single woofer plus choke from the power amplifier of one channel only. This may seem very crude, because the woofer does not receive the proper sum signal, but the fact remains that it is fairly satisfactory in practice. It is conceivable, of course, that one might come across a stereo record with nearly all the low bass in the channel not feeding the woofer, but the author has yet to meet such a case among classical records!

If, however, the above simple solution does not seem attractive, there is more than one possible way of feeding the woofer with a genuine sum signal. A very satisfactory method is to connect the woofer plus choke between the live output terminals of the two power amplifiers and introduce a simple unity-gain phase-inverting stage at a suitable point in one channel, probably between the control unit and the power amplifier. The connections to one of

the smaller loudspeakers must, of course, also be reversed, to restore the loudspeaker outputs to their correct phasing. (The alternative scheme of reversing the connections to one half of the stereo pickup is not such a good idea as it might at first sight appear to be—quite apart from the fact that it does not cater for the stereo radio aspect of the problem. This is because, while it will work all right under stereo conditions, the normal control unit switching arrangements connect the two halves of the pickup in parallel under mono conditions, giving, ideally, zero output if the connections to one half have been reversed.)

An incidental advantage of feeding the woofer from the two power amplifiers as just described is that the signal level is 6 dB higher than when fed from only one amplifier, assuming the two amplifiers give in-phase contributions to the woofer at these very low frequencies.† If the bass output is too powerful, it may, of course, be reduced by decreasing the choke gap, but it is probable that the extra output at these very low bass frequencies will be felt to be beneficial in most rooms.¹

An alternative and equally effective method for obtaining the sum signal for feeding the woofer is shown in Fig. 10. The transformer can employ a Belclere Kit LX, as used for the woofer choke, each winding consisting of 150 turns (in one section) of 24 s.w.g. enamelled wire. The laminations should be interleaved, i.e., no gap.

The connection of a transformer, as in Fig. 10, directly across the output of some transistor amplifiers of the type having no output transformer, is, however, inadvisable, being likely to lead to the breakdown of one or both of the output transistors should an accidental very-low-frequency overload occur—caused, for example, by mishandling the pickup. This is because the transformer inductance presents the transistors, at very low frequencies, with a low value of almost purely reactive load, giving an instantaneous combination of high collector current and high collector voltage not met under more normal load conditions. No trouble with such breakdown effects is likely to be experienced with valve amplifiers, however.

An economical scheme, which feeds the woofer with a genuine sum signal without requiring a transformer, and which can be used quite safely with a transistor amplifier, involves connecting two resistors, of about 15 Ω each, in series between the live output terminals of the two power amplifiers, the woofer and its series choke being fed from their junction. While this arrangement draws extra power from the amplifiers, and gives reduced electro-magnetic damping of the woofer, it has been found to work quite nicely in practice. The resistors should preferably be wire-wound, with a rating of at least 3 W each.

Yet another arrangement, which may be favoured by readers possessing a spare mono amplifier, is shown in Fig. 11. It is here assumed that the amplifier input impedance is at least 100 kΩ. If it is lower than this, the impedance values in the circuit should all be reduced appropriately.

The circuit shown in Fig. 12, which is believed to have been used on the Continent, has the advantage of requiring neither special iron-cored components nor an extra amplifier. It cannot be strongly recommended, however; the resonant interaction of the motional impedances of the three loudspeakers leading to peculiar dips and peaks in the frequency response which are difficult to predict or control satisfactorily.

A system employing a single woofer operated off the sum signal can give considerably less turntable rumble than a normal system, and this is a very real advantage. Rumble vibrations tend to be largely in a vertical plane, and the single woofer is non-responsive

† An objection to the scheme might seem to be that each amplifier will "see" a load impedance of only half the woofer-plus-choke impedance. However, because the impedance of a nominally 15-Ω speaker is much higher than 15 Ω in the region of its resonant frequency, except, perhaps, if it is mounted in a phase-inverter cabinet, and because of the high impedance of the choke at higher frequencies, it is found in practice that there is little reduction in the apparent power-handling capability of the system.

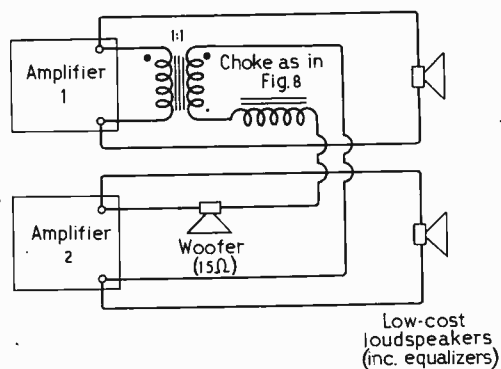

Fig. 10. Stereo system with phase-inverting transformer for feeding woofer.

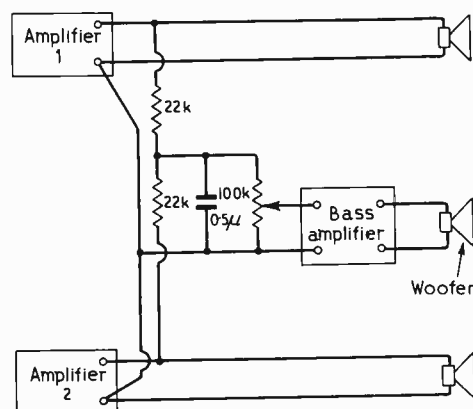

Fig. 11. Stereo system with separate amplifier for feeding woofer.

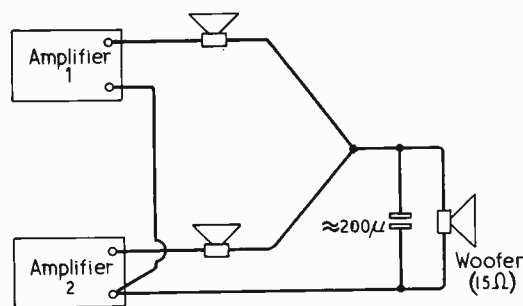

Fig. 12. Simple stereo system with capacitor across woofer—not strongly recommended.

to vertical stylus movements, which normally represent the stereo difference signal. When two separate full-range loudspeakers are used, vertical stylus movements give, ideally, equal and antiphase outputs from the loudspeakers, but, because of acoustic effects in the room, the outputs do not, in general, cancel at the listener's ears—indeed, if they did, there would be no stereo effect! The loss of stereo effect inherent in the use of a single woofer does not seem to matter, provided, as in the present scheme, it is confined to very low frequencies only.

Measurements on the drive unit

The electro-mechanical constants of the loudspeaker drive unit were determined by the following set of measurements and calculations.

The unmounted loudspeaker unit was placed face upwards on a table and fed at low level from an oscillator via a 1,000-Ω series resistor. An oscilloscope (10 mV/cm sensitivity) connected across the speech coil enabled the oscillator to be set to the diaphragm resonant frequency, f_0 , as indicated by a maximum waveform amplitude. A series of ordinary brass balance weights was then carefully placed on the diaphragm near the coil, giving modified values of resonant frequency. A graph of $(1/f_0)^2$ against the mass added was then plotted. This was a good straight line, with an intercept at -5.7 gm, so the effective diaphragm mass was taken to be of this magnitude. The total mass corresponding to a particular resonant frequency could then be obtained, enabling the diaphragm

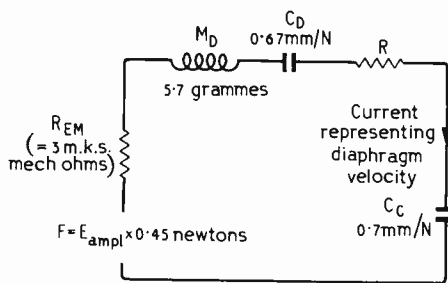

Fig. 13. Analogous electrical circuit representing mechanical system of loudspeaker unit and cabinet.

suspension compliance to be determined from the relationship:

$$f_o = \frac{1}{2\pi\sqrt{MC}} \quad (1)$$

where: M = mass in kilogrammes, C = compliance in metres per newton, f_o = resonant frequency in Hz.

The value obtained for the compliance was 0.67 mm/N.

A little wire tripod was then made, whose feet rested on the junction between the central dome and the paper diaphragm. This tripod carried a fine pointer arranged to indicate displacement against a scale of millimetres fixed to a wooden "bridge" resting on the loudspeaker frame. With care, it was found possible to estimate tenths of a millimetre. Measured direct currents were then passed through the coil, in both directions, and a graph of displacement against current plotted. This was fairly straight, with a slope of 4.5 mm/amp, up to about ± 1 mm. From this figure, and the compliance figure previously obtained, a force/current relationship of 6.7 newtons/amp was deduced.

The aim was to obtain all the values of the mechanical elements represented by the analogous electrical circuit of Fig. 13^{8,10}†. The suffixes D and C are used for quantities associated directly with the diaphragm and cabinet respectively. F is the force which would be produced by the speech coil if it were prevented from moving. This force, as already mentioned, is 6.7 N/A. If E is the amplifier output e.m.f. in volts, and if we take the sum, R_{tot} , of the coil resistance (13.5 Ω) and the amplifier output resistance as 15 Ω , then $F = 6.7 \times E/15$, i.e., $F = E \times 0.45$ newtons.

R_{EM} in Fig. 13 is the mechanical resistance introduced by electromagnetic damping, i.e., it is the ratio of the force produced by the speech coil when blocked to the velocity it would have if completely free and massless. It may be shown that:

$$R_{EM} = \left(\frac{F}{I}\right)^2 \times \frac{1}{R_{tot}} \quad (2)$$

where: F/I is in N/A, R_{tot} is in ohms, R_{EM} is in m.k.s. mechanical ohms.

For the present loudspeaker unit, R_{EM} comes out at 3 m.k.s. mechanical ohms.

C_C is the compliance associated with the volume of air enclosed in the cabinet, referred to the diaphragm. It is obvious that the larger the diaphragm area, the greater will be the increase of air pressure in the cabinet for a given diaphragm movement, and that a given increase in pressure will produce a force on the diaphragm proportional to its area. Hence:—

$$[\text{Air compliance}]_{\text{w.r.t. diaphragm}} \propto \frac{\text{cabinet volume}}{(\text{diaphragm area})^2} \quad (3)$$

(An alternative method of calculation involves the use of acoustical impedances rather than mechanical impedances. Acoustical impedance is pressure/volume-current rather than force/velocity. Compliance is then volume change/pressure and is a function of cabinet volume only and not diaphragm area.)

† The analogy used is that voltage represents force, current represents velocity. Hence voltage/current, i.e., electrical impedance, represents force/velocity, i.e., mechanical impedance. Just as the reactance of an inductance L is $2\pi fL$, so the mechanical reactance of a mass M is $2\pi fM$ mechanical ohms, etc.

When the air in the cabinet is suddenly compressed, its temperature rises. If the increased pressure is maintained, the air will cool down again, giving a further volume reduction. Thus, for very slow changes, the compliance is higher than for faster changes. When, as normally applies for a loudspeaker cabinet, even at low audio frequencies, there is no time for the air to cool down after compression, the operation is said to be adiabatic, as compared with isothermal for very slow changes.

The effective diaphragm area for the Elac unit used, measured to the "mid-point" of the surround, is approximately 0.0164 sq m. The effective cabinet volume is approximately 0.0252 cu m. This leads to the result that, with adiabatic operation, the compliance of the air, referred to the diaphragm, is 0.70 mm/N.

It will be noticed that the compliance due to the air is about equal to that of the unit itself, giving a rise in resonant frequency by a factor of about $\sqrt{2}$. The calculated resonant frequency in the cabinet is 114 Hz, which agrees quite reasonably with that determined experimentally. (A complicating factor is that it is found in practice that the resonant frequency of the unit depends considerably on the applied voltage at which it is measured.)

The remaining element to be determined in Fig. 13 is the mechanical resistance R , representing diaphragm suspension losses and radiation resistance. The latter varies rapidly with frequency, but the value of R at the resonant frequency is of particular interest. One of the simplest methods for determining R is to connect the contacts of a relay in series with the speech coil and a d.c. supply such as a dry cell. The relay is operated at some quite low frequency, e.g., 1 Hz, by means of a multivibrator, or in some other convenient way. When the contacts open, the electrical resistance in the speech-coil circuit becomes infinite, making R_{EM} zero. The only resistance effective in the mechanical circuit is then R , and a damped oscillatory voltage appears across the coil, as shown in Fig. 14. The Q value may be determined from the rate of decay of the oscillation, and a convenient fact is that the Q value is equal to the number of half cycles that occur while the oscillation amplitude is decaying from a value of unity to a value of 0.21 of unity. This test performed on the present loudspeaker, with no felt in the cabinet, gave a Q value of 15 and a natural frequency of 110 Hz. The reactance of the 5.7 gm diaphragm mass at 110 Hz is 3.9 m.k.s. mechanical ohms, so that, with $Q = 15$, R is $3.9 \div 15$, i.e., 0.26 m.k.s. mechanical ohms. Thus, when the unit is fed from a low impedance source, the total mechanical resistance is 3.26 m.k.s. mechanical ohms, and the Q value is $3.9/3.26$, i.e., 1.2.

It was interesting to observe that, while a nice simple exponentially damped sine wave was obtained with the cabinet properly sealed, quite a small leak, such as that mentioned earlier, caused by incorrectly-fitted expanded aluminium, converted the waveform to a much more complex one, somewhat as sketched in Fig. 15.

The question now arises as to how much of the above 0.26 m.k.s. mechanical ohms figure for R is caused by radiation resistance. The diaphragm area of 0.0164 sq m is the same as for a circular diaphragm of radius 7.2 cm. The radiation resistance seen by a diaphragm, which is 420 m.k.s. mechanical ohms per sq m at high frequencies, where the wavelength is small compared with the diaphragm radius, falls off inversely as the square of the frequency⁸ from a corner frequency at which radius/wavelength = 0.25. For a radius of 7.2 cm, the wavelength is thus 28.8 cm, corresponding to a frequency of 1170 Hz. Hence at any frequency, f , considerably lower than this, the radiation component of the

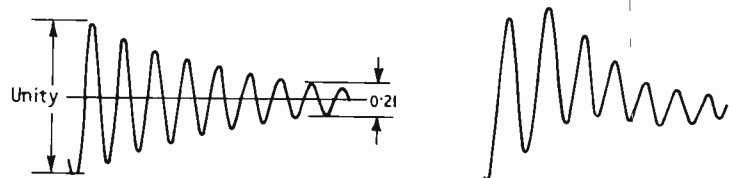

Fig. 14 (Left). Open-circuit coil voltage following interruption of current.

Fig. 15 (Right). As for Fig. 14, but with air leak in cabinet.

mechanical resistance in Fig. 13 is $0.0164 \times 420 \times (f/1170)^2$, i.e., $5.0 \times 10^{-6} f^2$ m.k.s. mechanical ohms.

The acoustical power radiated is equal to the square of the diaphragm velocity times this radiation resistance—equivalent to " $P = I^2 R$ " in an electrical circuit. Hence the radiated power will be independent of frequency if the diaphragm velocity is proportional to $1/f$. At frequencies well above resonance in the Fig. 13 circuit, the reactance of M_D becomes the dominant mechanical impedance, giving a velocity of $F/2\pi f M_D$. As already discussed, $F = E \times 0.45$ newtons, M_D is 5.7 grammes. The radiation resistance is $5.0 \times 10^{-6} f^2$ m.k.s. mechanical ohms. Hence the power radiated is:

$$\left[\frac{E \times 0.45 \times 10^5}{2\pi f \times 5.7 \times 10^{-3}} \right]^2 \times 5.0 \times 10^{-6} f^2 \text{ W}$$

$$= E^2 \times 0.80 \text{ mW.}$$

A 10-W amplifier designed for a 15- Ω load will give an output voltage of 12.2 V r.m.s., so that, from the above, the acoustic output from the loudspeaker at 10-W level is 120 mW. Hence, for practical purposes, the efficiency may be taken as 1.2%.

In the Fig. 13 circuit, the power output is (current)² \times (radiation resistance). But radiation resistance is proportional to (frequency)². Hence power output is proportional to (current \times frequency)². Now the voltage across the inductance is proportional to (current \times frequency), and this leads to the useful idea, pointed out by D. E. L. Shorter in reference 2, that the output power is proportional to the square of this voltage, or the pressure produced by the loudspeaker in free space is proportional to the voltage across the inductance. In this context, the circuit may conveniently be redrawn as shown in Fig. 16. This is a well known circuit,

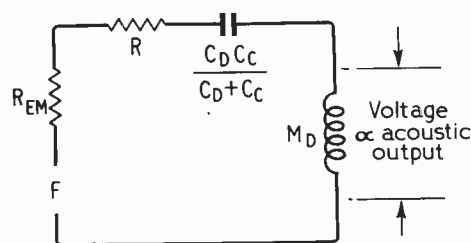

Fig. 16. Rearrangement of Fig. 13.

whose normalized frequency response, is given in reference 11. With a Q -value of 1.2, as determined above, the response would be expected to exhibit a peak of 2.4 dB just above the resonant frequency and to become asymptotic at very low frequencies to a 40 dB/decade (12 dB/octave) line going through 0 dB at the resonant frequency. The measured acoustic frequency response of the loudspeaker, Fig. 5 in Part I, will be seen to approximate fairly closely to this at low frequencies.

In conclusion, readers employing Vinkor for mounting clips for the equalizers may find it convenient to order mounting boards. These are DT2233 for the larger core and DT2227 for the smaller core. If, however, the whole equalizer is built on a piece of 1/16th inch s.r.b.p., holes for attaching the clips may be drilled in this and there is no need to employ Mullard boards.

REFERENCES

8. "Elements of Acoustical Engineering" by H. F. Olson. D. Van Nostrand, New York.
9. "Analysis and Measurement of Programme Levels" by D. E. L. Shorter and W. I. Manson. B.B.C. Engineering Monograph No. 16, March 1958.
10. "Dynamical Analogies" by H. F. Olson. D. Van Nostrand, New York (1958).
11. "Electric Circuits" by M.I.T. staff. John Wiley (1943). See p. 328, Fig. 33a.

Image intensifier for the visible spectrum

Fibre optics are used for high-efficiency transfer of optical images between three photo-electric stages in a new image intensifier tube introduced by Mullard for "seeing in the dark" in the visible spectrum. Originally produced in collaboration with Government establishments for military purposes, the tube has now been made available for civil use. Possible applications include navigation, aerial reconnaissance, space and underwater exploration, astronomy, nature studies of nocturnal animals, and aiding police and other authorities in night surveillance. The tube also makes possible the use of closed-circuit television in conditions of very low ambient lighting.

The tube uses a wide-diameter objective lens to collect as much as possible of the light reflected by the object or scene being observed. This optical image is focused on to the photocathode of the first stage, producing a corresponding pattern of electrons. These electrons are then directed and accelerated by an electrode system connected to a potential of 15kV, and fall on a phosphor screen. Because of their high velocity they cause more photons to be emitted from this screen than were received by the photocathode. Hence the original image is intensified. To ensure that as much of the light as possible is transferred from the phosphor screen of the first intensifier stage to the input photocathode of the second stage (and so on) the optical image is transferred by fibre optics. The input and output windows of the stages are plano-convex, giving flat images and so simplifying optical coupling. Finally, a visible image is produced on a small screen 25mm in diameter. According to the manufacturers, the sensitivity of the tube makes it possible to clearly recognise objects under starlight conditions.



The image intensifier being demonstrated by Daphne Lamport, project leader of the group responsible for the early development of the tube.

Test Your Knowledge

Series devised by L. Ibbotson*, B.Sc., A.Inst.P., M.I.E.E., M.I.E.R.E.

4: Noise

1. Of the noise which arises in electronic equipment and in communication systems some types are considered "avoidable" and others "unavoidable". Select the "unavoidable" source of noise from those listed below:
 - (a) noise due to power supply ripple
 - (b) noise due to component microphony
 - (c) Johnson noise
 - (d) carbon resistor noise.
2. Only one of the following sources of noise is significant at frequencies above 30MHz:
 - (a) semiconductor current noise in transistors
 - (b) cathode flicker-effect noise in valves
 - (c) atmospheric noise due to lightning
 - (d) noise from car ignition systems.
3. "White noise" is noise for which the available power in a given bandwidth:
 - (a) is greatest at low frequencies
 - (b) is the same at all radio frequencies
 - (c) is greatest at high frequencies
 - (d) exists in the visible part of the electromagnetic spectrum only.
4. The maximum available noise power from a resistor of value R is:
 - (a) proportional to R
 - (b) proportional to \sqrt{R}
 - (c) proportional to R^2
 - (d) independent of R
5. A loss-free capacitor and a resistor have the same impedance magnitude and are at the same temperature. The available noise power from the capacitor is:
 - (a) the same as that from the resistor
 - (b) greater than that from the resistor
 - (c) less than that from the resistor
 - (d) zero.
6. A resistor of value 400 ohms is maintained at a temperature of 300°K, and a resistor of 300 ohms is maintained at 400°K. The two are connected in parallel. As a result:
 - (a) the 300-ohm resistor delivers noise power to the 400-ohm resistor
 - (b) the 400-ohm resistor delivers noise power to the 300-ohm resistor
 - (c) the net exchange of noise power is zero
 - (d) both resistors show a net absorption of noise power.
7. The noise produced by a bipolar transistor:
 - (a) is independent of emitter current
 - (b) increases uniformly with increasing emitter current
 - (c) decreases uniformly with increasing emitter current
 - (d) has a minimum value for a particular emitter current.
8. The noise produced by a valve can be represented by an equivalent noise resistance at its grid. Which of the following has the largest equivalent noise resistance?
 - (a) a pentode
 - (b) a triode
 - (c) a hexode mixer valve
 - (d) a beam tetrode.
9. A signal source having a small internal resistance R_s feeds an amplifier with a large resistive input impedance R_i . The maximum signal-to-noise ratio at the amplifier output is obtained by:
 - (a) connecting the source directly to the amplifier input
 - (b) coupling the source to the amplifier by a step-up transformer which matches the source impedance to the amplifier input impedance
 - (c) using a step-up transformer to make the transformed source impedance very much greater than R_i
 - (d) using a step-up transformer to bring the transformed source impedance to a value lying between R_s and R_i .
10. The "noise figure" of an amplifier is:
 - (a) the ratio of the total output noise power from the amplifier to the output noise power originating from the signal source
 - (b) the ratio of the output noise power originating in the amplifier to the output noise power originating from the signal source
 - (c) the noise power output from the amplifier with the input open-circuit
 - (d) the noise power output from the amplifier with the input short-circuit.
11. An amplifier has an "equivalent noise temperature" T_n . The expression $k T_n B$ (where k is Boltzmann's constant, B the bandwidth of the amplifier) is:
 - (a) the available noise power at the output of the amplifier
 - (b) the total noise power of the amplifier and source referred to the input terminals of the amplifier
 - (c) an available noise power, to be added to that of the source at the input, representing the noise produced in the amplifier
 - (d) the fraction of the output available noise power which is due to noise produced in the amplifier.
12. The noise temperature of a directive aerial is:
 - (a) ambient temperature (around 280°K)
 - (b) always above ambient temperature
 - (c) always below ambient temperature
 - (d) sometimes above ambient temperature sometimes below.
13. In a radio system using a v.h.f. carrier the signal-to-noise ratio at the output is not significantly improved by:
 - (a) increasing the transmitter power
 - (b) increasing the gains of the aerials
 - (c) increasing the receiver i.f.-sensitivity
 - (d) cooling the receiver input circuit.
14. A receiver for normal amplitude modulated signals uses a diode detector, which may be assumed to be linear, as an envelope detector. The signal-to-noise ratio of the audio frequency output from the detector will be:
 - (a) the same as that of the i.f. input to the detector
 - (b) less than that of the i.f. input to the detector
 - (c) more than that of the i.f. input to the detector
 - (d) zero.
15. The B.B.C. v.h.f./f.m. radio broadcasting system can give a very high output signal-to-noise ratio. The main reason for its inherent superiority over a medium wave a.m. system is:
 - (a) the better noise performance of an f.m. system as compared to an a.m. system using the same bandwidth
 - (b) the wide peak frequency deviation used
 - (c) the use of the v.h.f. band
 - (d) the use of horizontal polarization.
16. In order for communication to be possible over a given channel the overall signal-to-noise ratio must be:
 - (a) greater than zero
 - (b) greater than 1
 - (c) greater than 2
 - (d) greater than 10.

* West Ham College of Technology, London, E.15.

Wireless World Colour Television Receiver

4. Line timebase and power supply

Space did not permit all details of the line timebase to be given in Part 3, so the discussion of the timebases will be completed here before going on to the power-supply unit, which is a reasonably simple and straightforward affair. The arrangement of the components in the timebase unit is by no means critical and it is not necessary to give precise details of the layout. Most of the small components are carried on the four tagboards and other components are mounted in convenient positions on the chassis or, if small enough, are mounted between the tags of valveholders and other components.

The wiring, too, is by no means critical and no difficulty should arise if common sense is used. Ample clearance around all high-voltage points must be allowed. There must be no sharp points anywhere at high voltage, and this means from about 5kV upwards. If flexible wire is used, make sure that all the ends of all the strands are embedded in solder and that the solder itself forms a nice smooth blob.

All the controls except the coarse line-frequency control are mounted on the front edge of the chassis and their positions can be seen from one of the photographs in this article. Most of these can be regarded as pre-set controls; ideally, they would all be such. However, it is felt that the line and field hold controls should really be brought out as panel controls, for it cannot be guaranteed that either timebase will always lock in when the set is switched on from cold.

If initial testing is done without any sync pulses, care must be taken not to operate the line timebase far from its correct frequency. If it is run at much too low a frequency the output valve may be damaged, for the peak and mean currents become much too high. In fact, the anode may even run red hot! The frequency can be checked using an oscilloscope with a calibrated time scale; the time of one cycle should, of course, be 64 μ sec. A wire held near the line unit will pick up ample signal and will represent the voltage, not the current, waveform. It should be approximately a half sinewave in shape and of 12 μ sec width. It should be substantially free from ripples, as should be also the interval between these pulses. This interval represents the scan period and the voltage waveform will appear substantially constant during it, the variations which do exist being too small to see if the flyback pulse is fully visible on the oscilloscope.

The position is quite different in the case of the frame timebase. Here a direct connection of the oscilloscope can be made to the transformer secondary and there is a large amplitude of sawtooth and quite a large flyback pulse. It will be found that there is an appreciable amplitude of line frequency superimposed on the field timebase output. This is admittedly undesirable since it is liable to affect the interlacing and normally one would go to considerable lengths in screening and decoupling to avoid it. However, in this case the line and field outputs are deliberately coupled together by a special transformer and this inevitably introduces line pulses into the

field circuits. It has not been felt worthwhile, therefore, to take elaborate precautions against other forms of coupling.

This transformer is really a transducer and is included in the convergence control unit and so will be fully treated in the article which describes that unit. Its purpose is to avoid the pincushion distortion of the raster which would otherwise occur. In monochrome television this can be avoided by an appropriate design of the deflector coils. With colour, the requirements of convergence prevent this solution from being adopted. It is necessary, therefore, to modulate each scan current at the frequency of the other. The two are coupled by a saturable-core transducer which provides the necessary non-linearity for the intermodulation of the two currents.

Under normal operating conditions with a video signal fed to the cathodes of the tube and to the sync separator in the

The front end of the timebase unit showing the controls

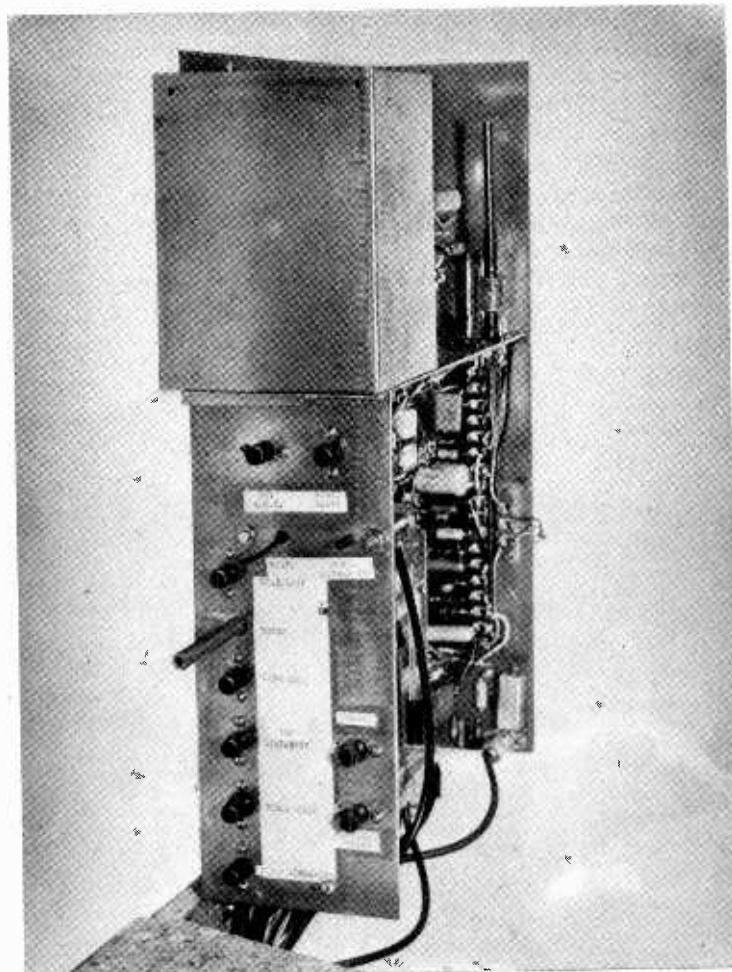

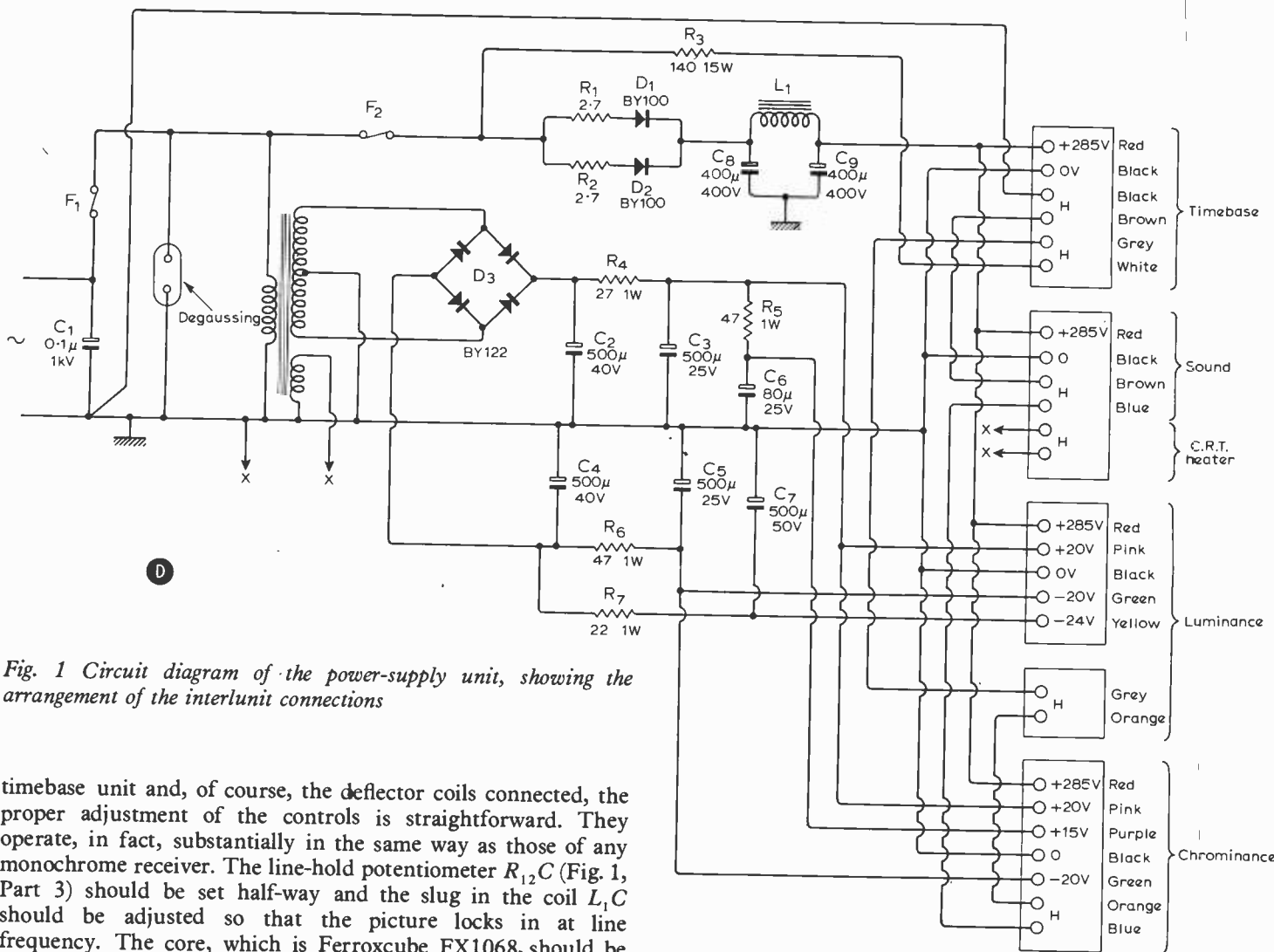

Fig. 1 Circuit diagram of the power-supply unit, showing the arrangement of the interlunit connections

timebase unit and, of course, the deflector coils connected, the proper adjustment of the controls is straightforward. They operate, in fact, substantially in the same way as those of any monochrome receiver. The line-hold potentiometer $R_{12}C$ (Fig. 1, Part 3) should be set half-way and the slug in the coil L_1C should be adjusted so that the picture locks in at line frequency. The core, which is Ferroxcube FX1068, should be made a tight fit in the coil former by wrapping it with Sellotape if necessary; if it is an easy fit it will inevitably shift of its own accord. This coil, by the way, is ideally wavewound with 2,000 turns of No. 42 enamelled wire tapped at 500 turns from the start. The start goes to the screen grid of V_2C and the end to the control grid. If a wave-winding machine is not available cardboard cheeks $\frac{5}{8}$ inch apart can be fitted to the former, which is of $\frac{1}{4}$ inch o.d., and the coil scramble-wound.

Turning now to the power-supply unit, the circuit diagram is shown in Fig. 1. Two fuses are fitted, one F_1 in the mains

input and the other F_2 after it in the input to the 285 V and heater supplies. This is not so much for special protection as to afford an easy means of rendering the supply inoperative by removing the fuse. This is desirable when working with test equipment on the transistor units as, for example, when aligning the i.f. amplifiers.

The main h.t. supply is provided by two BY100 rectifiers in parallel, but with a 2.7- Ω resistor in series with each to ensure

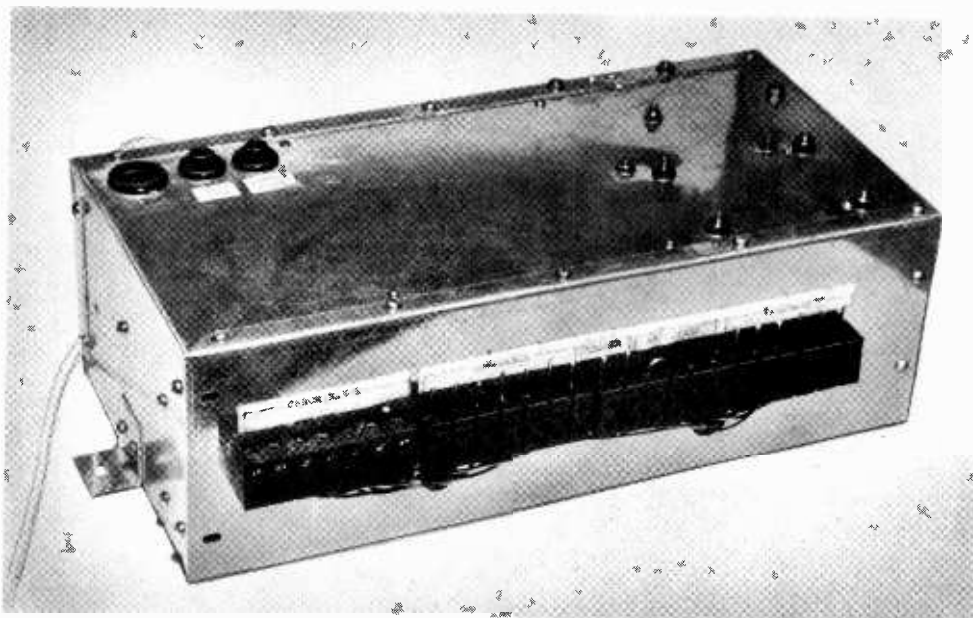

Power-supply unit with connectors on the rear

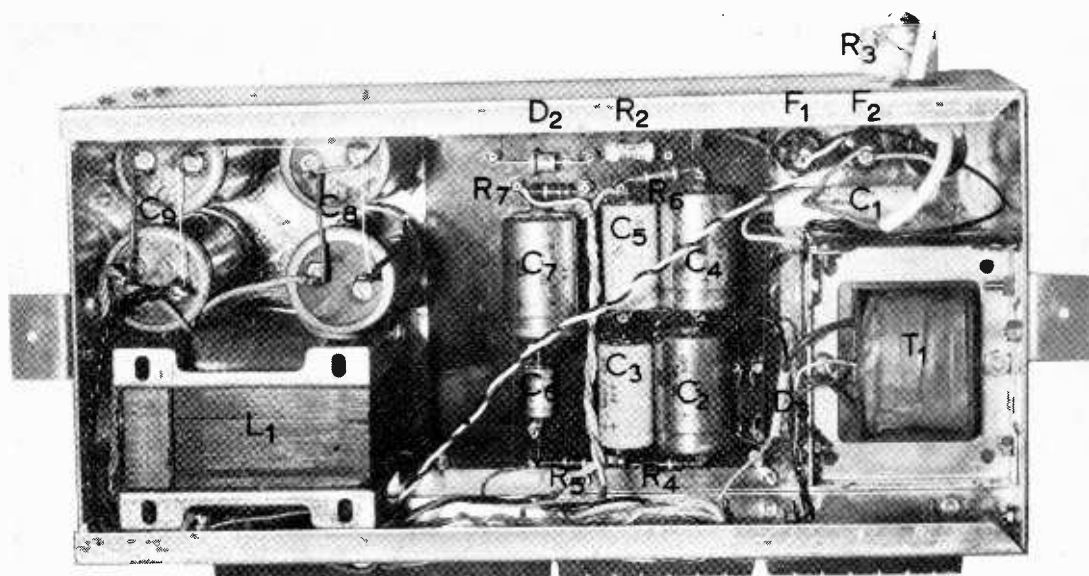

Inside the power unit. The heater dropping resistor R_3 is mounted externally

equal distribution of current between them. The reservoir capacitance is C_8 of $400\ \mu\text{F}$, and smoothing is provided by the choke L_1 of 1.3 H and a further capacitance C_9 of $400\ \mu\text{F}$. Each of these actually comprises two $200\text{-}\mu\text{F}$ capacitors in parallel. The choke specification is 1.3 H with a d.c. resistance not more than $25\ \Omega$ and a current rating of 750mA. The one used was provided by Osmabet Ltd., of 46 Kenilworth Road, Edgware, Middx.

The transformer for the low-voltage supplies has a 230-V primary with a secondary of 35-0-35 volts at 240mA and a 6.3-V 0.9-A secondary for the heater of the colour tube. A BY122 rectifier is used. This is of the bridge type but one pair of rectifiers is used with the centre-tapped transformer winding to provide a supply positive to earth, while the other pair is used to give a supply negative to earth. The two reservoir capacitances C_2 and C_4 are each $500\ \mu\text{F}$, 40-V rating; the smoothing capacitors C_3 and C_5 are of the same capacitance but of 25-V rating only. The smoothing resistors are R_4 and R_6 of $27\ \Omega$ and $47\ \Omega$ respectively and the direct outputs are 20V and -20V. A supply at 15V is obtained through the $47\text{-}\Omega$ resistor R_5 with the $80\ \mu\text{F}$, 25-V capacitor C_6 . A supply at -24V is obtained through the $22\text{-}\Omega$ resistor R_7 with the smoothing capacitor C_7 of $500\ \mu\text{F}$, 50V. This is possible because it is a very low current supply which is needed for only one transistor in the a.g.c. circuits.

The chassis used is of aluminium, since it was felt to be undesirable to place iron near the tube. All components except the heater dropping resistor R_3 are mounted internally, and this is screwed outside at the back. It must be, of course, of 15W rating. The transformer and choke are mounted in the two back corners to be as far from the tube as possible; their spacing from the tube seems to be quite adequate.

For the external connections screw connectors are used and are cut up into suitable lengths from 12-way connectors type B7S1 of Home Radio. Connections to five separate units are necessary with two 7-way, one 5-way, one 4-way and one 2-way unit. These are cut from 12-way connectors and are screwed to the back of the chassis where they are readily accessible. The cables from the various units are terminated in a similar set of connectors and the two sets are joined together by short lengths of No. 16 gauge wire. By slacking off one set of screws any individual unit can be disconnected quite easily. What is more important it can be reconnected equally easily and without any fear of wrong connections.

All told, therefore, for the double set of connectors there are

required four 7-way, two 5-way, two 4-way and two 2-way units. Four 12-way units can be cut to provide everything except the two 2-way units; a different pattern can be used for these, or they can be cut from another 12-way unit to leave eight ways available for something else.

General Note

A number of readers has asked that we should publish a complete circuit diagram and list of parts for the *Wireless World* Colour Television Receiver in an early issue. It is not possible to do this because all details of the design have not yet been finalized.

Early this year the receiver development had reached a stage in which, as a black-and-white receiver, it was in a substantially final state but in which the colour section required a great deal more development of details. We estimated that it would take some six months more work to bring the colour section to the standard which we considered desirable.

It was apparent that we had two courses open to us. We could do what we actually did, which was to start right away with the description of the monochrome parts and trust that we should have been able to finalize the colour sections by the time the rest had been treated. Or we could defer everything until every detail had been finished.

By adopting the course which we have done full details of the whole equipment will be available to readers six months earlier than would otherwise have been practicable. It does, however, make it impossible for us to supply any information in advance of the normal publication of the articles.

Corrections

In Fig. 3 of Part 2 (July issue) the labelling 'Linearity' and 'Top Linearity' of R_{15} and R_{16} is reversed.

In Part 3 (August issue) the reference to $R_{30}C_{27}$ in line 16, column 1 of p.255 should be to $R_{40}C_{27}$. In Fig. 1 there are, unfortunately, three capacitors labelled C_{26} , one connected to the collector of Tr_1 , one $0.47\text{-}\mu\text{F}$, 1-kV between the A_1 output and chassis, and one $0.002\text{-}\mu\text{F}$, 10-kV, from the focus terminal of the e.h.t. unit to chassis. The first of these is also shown on Board 4, Fig. 4. The other two do not appear in other diagrams but are referred to in the text. The context, however, leaves no doubt about which is meant.

The reference to Board 3 in the caption to Fig. 3 should be to Board 2.

Literature Received

Mullard have recently published a large wallchart (78cm × 109cm) entitled **"The Shadowmask Picture Tube for Colour Television"**. The chart illustrates briefly the general principles of colour television and deals in detail with the construction and operation of a colour picture tube. It costs 5s, including postage and packing, and can be obtained from the Mullard Educational Service, Mullard Ltd., Mullard House, Torrington Place, London, W.C.1.

"Complis" is the title of a collection of tables compiled monthly from the pages of *Wireless World* listing the various types of semiconductor mentioned giving details of which advertiser stocks them and at what price. Each advertiser is allocated a number which appears at the head of a column on each page. One row on each page is devoted to a particular semiconductor type and the price quoted by each supplier is placed in that supplier's column. One is able, therefore, to see at a glance all the various prices for a particular device. The lists cost 2s 6d each and are available from Complis, P.O. Box 31, Cheltenham, Glos.

Electroniques policy of making professional components available to the home constructor has been followed to some extent in the current catalogue, the **1968 edition of the Hobbies Manual** which runs to almost 1000 pages and costs 16s 6d, about 50% of the contents being devoted to components. Also included are kits, complete domestic and 'ham' equipments, and a books section. Another section however, of 28 pages, is devoted to motoring and includes such items as a car vacuum cleaner, seat belts and compasses. Other diversions from the electronics field include, telescopes, binoculars, microscopes and an inflatable plastic globe. Electroniques, Edinburgh Way, Harlow, Essex.

The Association of Public Address Engineers have published **three technical bulletins** called: (1) "The 100 volt line loudspeaker distribution system", (2) "General workshop practice", (3) "General workshop instruments". This latter bulletin gives constructional information on a mains test box, a d.c. supply unit, an amplifier load output box, an audio oscillator, a resistor load box, two bridges, an oscilloscope and a beam switching unit. The three publications are available from the A.P.A.E., 394 Northolt Road, South Harrow, Middlesex, at 10s 6d each.

"Integrated Logic Applications" is a well produced booklet comprising 150 pages of information and circuits relevant to the Mullard FJ series t.t.l. family. Early sections of the booklet are devoted to general discussions concerning the use of t.t.l. and the hazards that may be encountered. Each subsequent section covers a particular type of circuit, i.e. shift registers, address, code converters, staticisers, error detectors, etc. A large number of logic diagrams are given in each section. Mullard Ltd., Mullard House, Torrington Place, London, W.C.1, price 5s.

"Connector Pictorial Charts" is the title of a booklet produced by Suhner Electronics Ltd, of 172/176 Kings Cross Road, London, W.C.1, which should be of interest to those concerned with the use of r.f. connectors in commercial and military applications. Each chart, 37 are included, shows a complete connector range and includes a photograph, U.S. military and equivalent N.A.T.O. numbers and brief details.

WW 361 for further details

"Valves and Teletubes", data list 34 received from Brimar, now consists of 64 pages, a 25% increase over earlier editions, as it contains some of the features that were normally incorporated in the "Brimar Manual" which is no longer available. The extra information includes some representative circuits; audio amplifiers, a line timebase and an electrometer. The rest of the contents is much as one would expect in this sort of publication incorporating valve lists, abridged data, equivalents lists, etc. Thorn-A.E.I. Radio Valves and Tubes Ltd., 7 Soho Square, London, W.1.

WW 362 for further details

A leaflet, designated WE42, issued by Sangamo Weston Ltd., St. Georges Court, 22-26 New Oxford Street, London, W.C.1, gives details of a range of **moving-coil instruments** that comply with D.E.F. 62. The meters have steel cases with solder and rip-wire seals built to withstand very severe environmental conditions.

WW 364 for further details

We have received a copy of the **"M.C.P. Product Guide"** which lists a selection of semiconductors available from M.C.P. Electronics Ltd., Station Wharf Works, Alperton, Middlesex. The devices included cover the spectrum from d.c. to 2GHz; brief performance details are given.

WW 365 for further details

A new **condensed catalogue** has been produced by Westinghouse Brake & Signal Co. Ltd. 82 York Way, Kings Cross, London, N.1. This describes a range of silicon devices with current ratings from 500mA to 830A at voltages of up to 3kV and S.C.R.S capable of carrying currents up to 500A and withstanding voltages up to 2kV.

WW 366 for further details

"Electronics Grade" chemicals are listed in a booklet produced by Hopkin and Williams Ltd, Chadwell Heath, Essex. Hopkin and Williams used to supply solvents under the trade name Ultrazol, but now that their range of products has become so diverse, the majority of the chemicals not being solvents, they have dropped this name.

WW373 for further details

H. F. Predictions—September

Seasonal change is evident as a slight increase in peak MUFs. This is sustained during daylight on all the routes except Hong Kong which develops a continuously varying MUF. Day-to-day MUFs are assumed to be normally distributed about that shown, the FOT (optimum traffic frequency) being the value exceeded on 90% of days. This is of interest to the regular communicator whilst a curve displaced by the same linear amount above the MUF would be of interest to amateurs and listeners as the MUF exceeded on 10% of the days. It is not possible however to predict which actual three days these will be.

LUFs depend very much on e.r.p., those shown were drawn by Cable & Wireless Ltd for reception in this country of point-to-point telegraphy transmitters using several kilowatts of power and rhombic aerials.

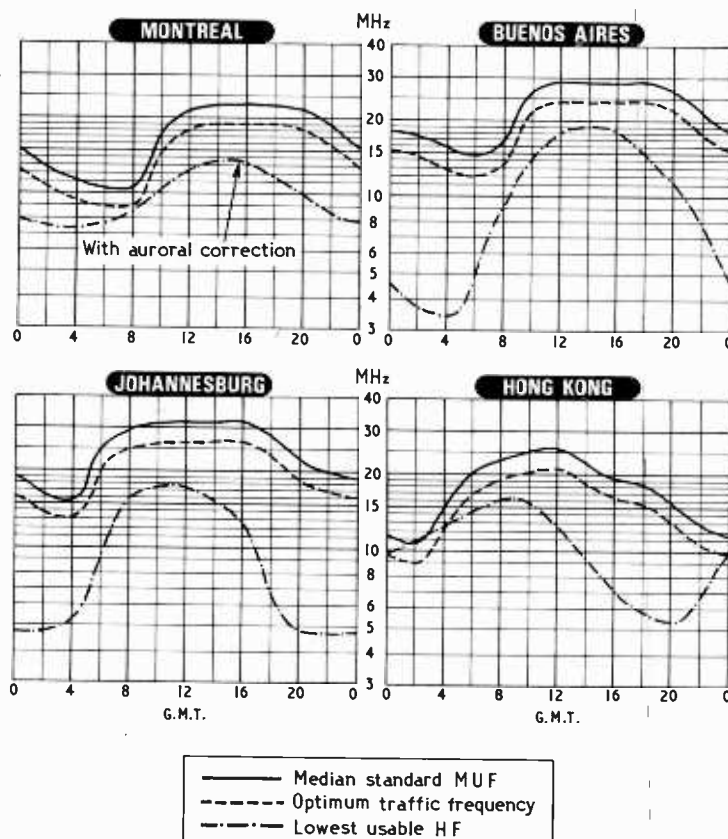

Demonstrating Radar Using Sonar

2: Construction and setting-up

by Brian A. Wyndham,* M.I.E.R.E.

*Royal Radar Establishment.

A dual trace oscilloscope having d.c. coupled Y inputs may be used to display the detected signals which have a maximum amplitude of 10 V. Triggering is available from the timing circuit of the transmitter. Such a presentation is usually called an "A" scope display, on which targets appear as vertical pulses whose position along the X axis is a measure of range. A time base speed of about 40 ms/sweep should be used. If an a.c. coupled deflection amplifier is employed the base line will tend to change its level according to the amount of signal present.

In operation, the detected output from the first amplifier is displayed to show the echo typical of a non-compressed pulse radar (or sonar). The output of the second amplifier, fed to the second channel of a dual trace oscilloscope, shows the narrower pulse due to compression. The switch S_a , S_b on the transmitter must be operated to show these two alternatives. As described, the circuit does not allow simultaneous presentation of both types of signal. For most purposes, this is not a serious disadvantage, but it should be mentioned that when the prototype has been exhibited publicly for relatively long unattended periods, electronic switching has been used to allow the two

channels to switch in synchronism with the dual trace oscilloscope, thus giving the effect of simultaneous presentation. Of course, if no pulse compression facility is included, a single trace oscilloscope is adequate.

Without pulse compression, two 18-V bias batteries will operate the device for many hours, since the current drain is only 27 mA from the positive supply and 65 mA from the negative, but the extra load of the pulse compression circuitry requires a more reliable source of power when used over long periods.

Many simple mains driven power supplies are available commercially and consequently no special unit has been designed for the prototype. However, the supply does not need a high degree of stabilization so that the simplest of rectifier and smoothing circuits could be used. Ripple should be reduced as far as possible otherwise this will appear as modulation on the signal.

Construction

For its original purpose of demonstrating a working model of a radar to a lay audience, it was thought desirable to make its appearance have some resemblance to the real thing, but apart from the reflector and

transducer positioning, the manner of constructing the container for the circuits is a matter of taste. However, for those readers who may like to construct such a device, the outline of the prototype is given (Fig. 7).

The body measures $30.5 \times 18 \times 11.5$ cm ($12 \times 7.5 \times 4.5$ in.) and is constructed of heavy gauge tinplate subdivided internally into three compartments. The lower compartment, which occupies the full width of the box, could house the batteries if no pulse compression circuitry is included, otherwise the second amplifier occupies this space. The upper half is divided by a vertical partition running the length of the box so as to form a left and a right half. One side holds the transmitter circuit and the other side the first amplifier. Two quick release side covers allow ready access to the circuits.

The two transducers are mounted in an aluminium block fixed to the top at one end of the box and the reflector is fixed to a bracket at the other end. Connections to the circuits run through holes in the blocks which line up with similar holes in the top of the body. Switches and sockets are mounted at the rear end.

The reflector is made of fibre-glass shaped to a circular paraboloid with a focal length of 25.4 cm (10 in.) and an overall diameter of 35.5 cm (14 in.). The paraboloid is then cut in half and the two pieces formed into off-set reflectors. In the prototype strengthening ribs were moulded on during fabrication and were used to secure the reflector to the supporting brackets. However, the constructor may find it more convenient to use sheet wood or metal instead of fibre glass.

The transformer in the transmitter has a ratio of 1:20 and consists of a primary of 15 turns of 12 s.w.g. enamelled copper wire and a secondary of 300 turns of 36 s.w.g. enamelled copper wire-wound on an LA5 core. The three receiver coils should be approximately $375 \mu\text{H}$. The circuits were built on printed circuit boards which are reproduced full size in Fig. 8.

Setting up

It will have been appreciated by now that the complexity of the pulse compression system will call for more special care in alignment than is required in the simple pulse version.

* Royal Radar Establishment.

Fig. 7. Outline drawings of the prototype sonar.

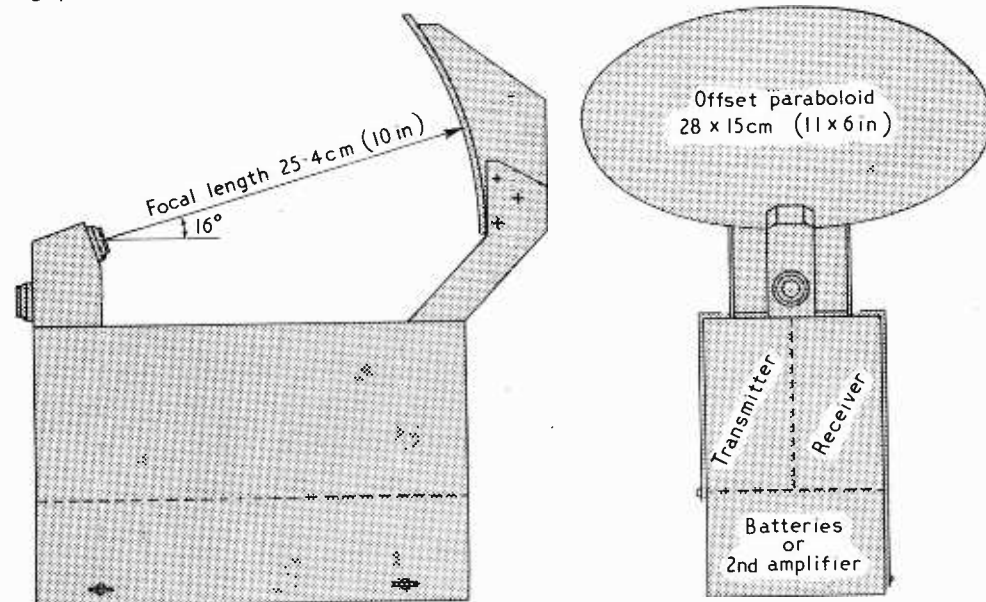

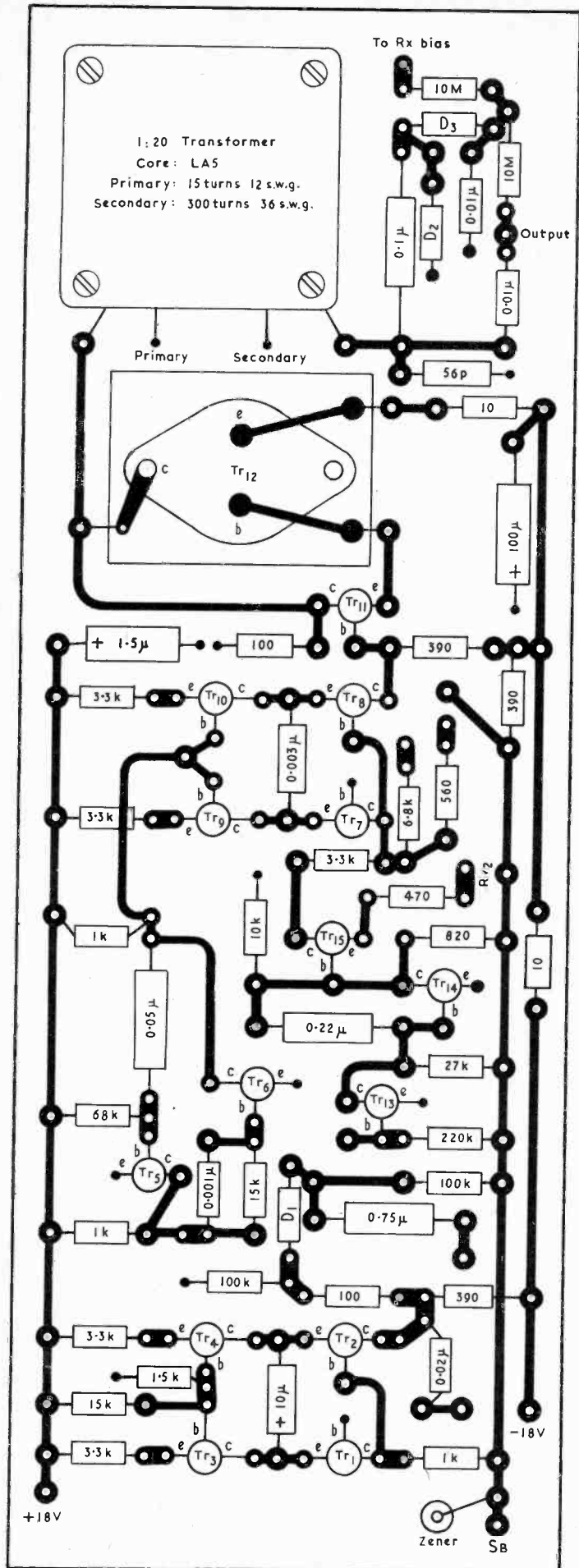
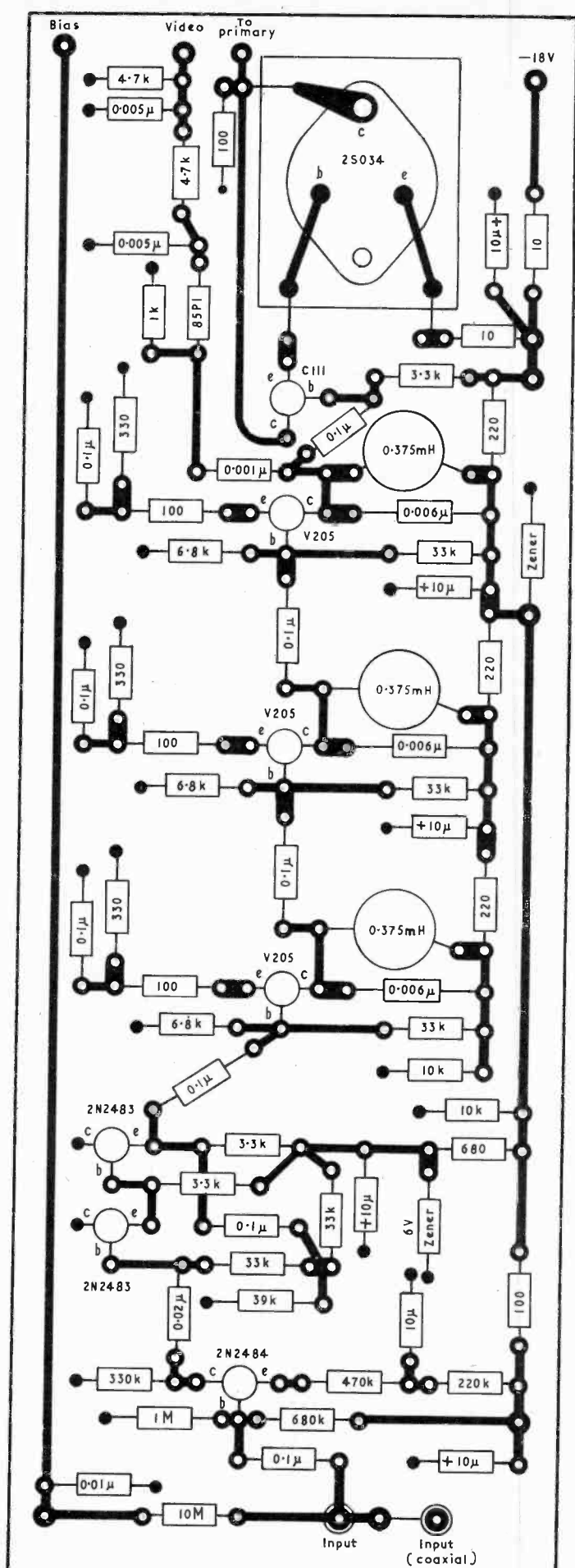
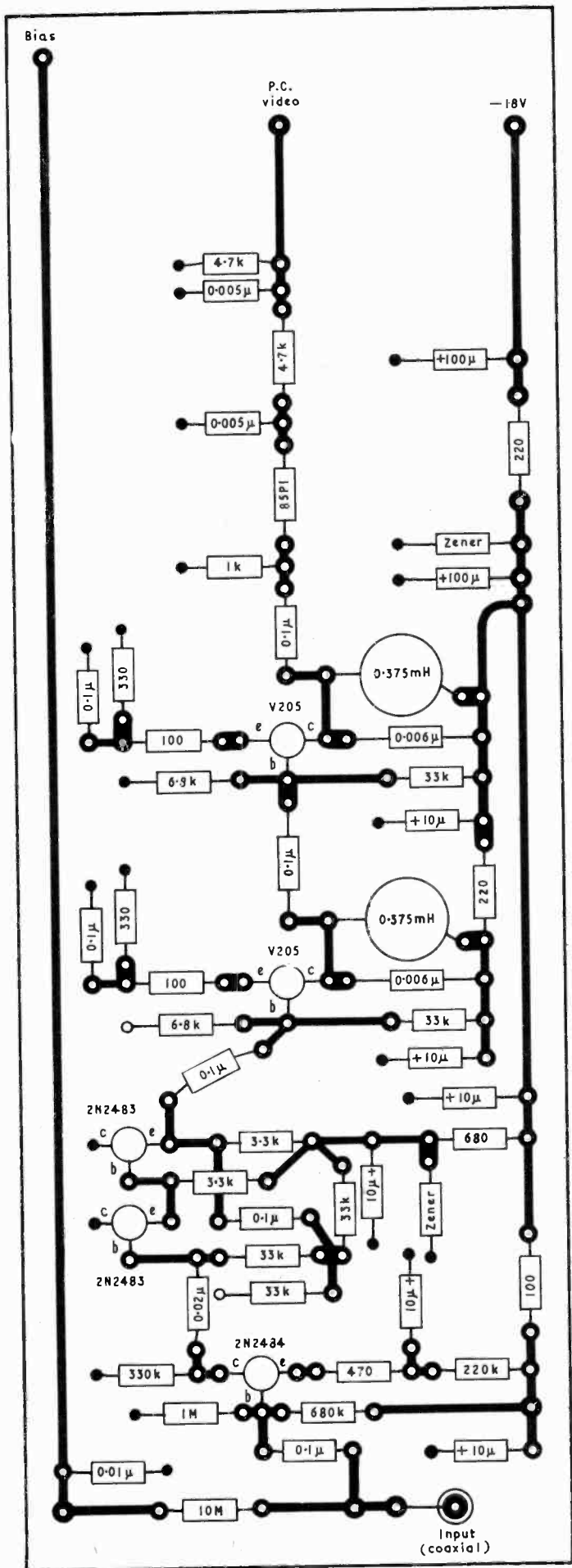

Fig. 8.(a) The transmitter printed circuit board.



(b) The receiver printed circuit.



(c) The second receiver amplifier printed circuit, pulse compression.

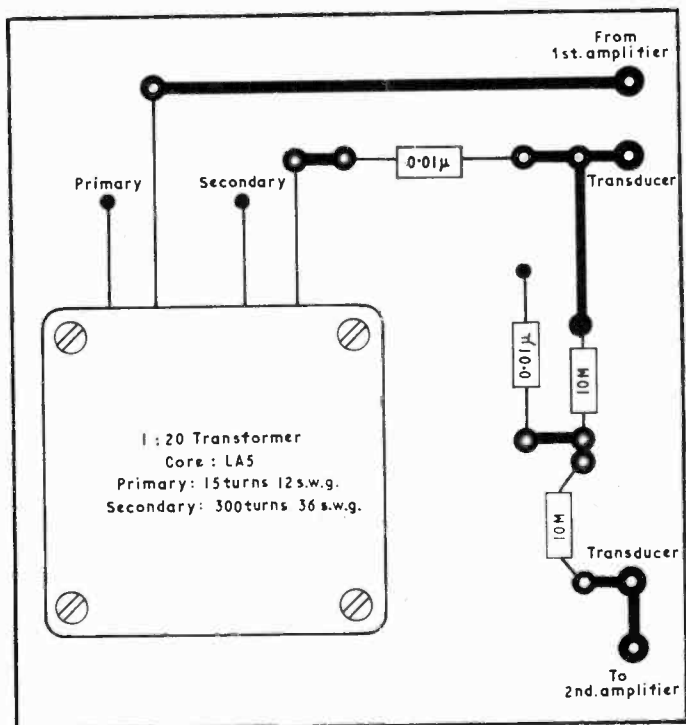

(d) Sub-chassis board, pulse compression only.

Fig. 8. General; All the printed circuit boards used are of the double-sided variety the reverse side being the common connection. To prevent component lead-out wires from shorting to the common connection some copper round lead-out holes is removed with a large drill

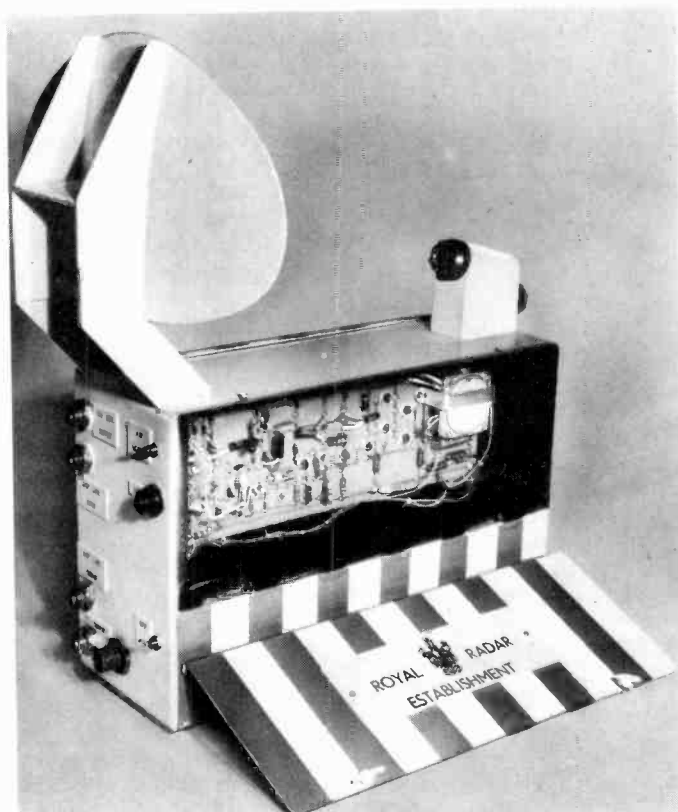

The prototype sonar with covers removed.

In the latter case it is only necessary to ensure that the receiving amplifier and the transmitted pulse are at the same frequency.

With pulse compression, the centre frequency and sweep range of the transmitted pulse must be aligned with the dispersive grating, since once constructed this is unalterable. A thorough understanding of the problem is the best basis from which to start, but the following notes are included as a guide to the procedure.

To avoid confusion as far as possible, the following nomenclature will be used:

Transducer (1) = main transmitting transducer

Transducer (2) = main receiving transducer

Transducer (3) = grating transducer coupled to 1st amplifier output

Transducer (4) = grating transducer coupled to 2nd amplifier input.

A signal generator operating in the range 90 kHz, to 120 kHz at least is required to ensure that all the receiving circuits are tuned to 102.4 kHz and have adequate bandwidth. This may sound vague but it depends on what one intends to demonstrate. A wider bandwidth allows the range sidelobes to appear unattenuated, giving poor adjacent signal performance but giving a convincing demonstration of the theoretical waveforms. A narrower bandwidth reduces the range sidelobes, with improved adjacent signal performance, whilst the range discrimination is deteriorated slightly. For the prototype, a compromise was reached with 7.5 kHz to 3 dB, since it was felt that waveforms help to convince sceptics who are also experts. The narrowest overall bandwidth

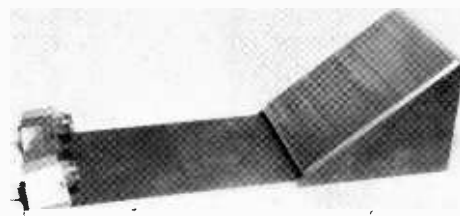

The ultrasonic dispersive grating.

used in full sized radars is such that it is 18 dB down at the extremes of the frequency sweep range.

It is better to centre the transmitter frequency to the grating first, ensuring that the pulse length is 1 ms. This could be done by temporarily connecting transducer (3) to the main transmitter output and examining the pulse on an oscilloscope connected to the emitter of Tr_3 in the second amplifier. The unswept pulse should appear as in Fig. 9(a). Switching to the pulse compression mode, the pulse should appear as in Fig. 9(b). Adjustment of Rv_1 and Rv_2 in the transmitter circuit will allow the best setting to be found.

The entire setting-up procedure could also be made using a small target without making any temporary alterations to the circuits, but it has been found that by eliminating the receiver circuits as far as possible, it is easier to identify any sources of error. A target echo should in any case be inspected at this point. A suitable target would be a table tennis ball suspended from a fine thread about 3 m (10 ft) away. The echo is first located using the unswept pulse as seen at the pre-grating detector. It should appear as a clean rectangular pulse. The second, post-grating detector, should show a pulse having the envelope of Fig. 9(a), a little later in time. Switching to pulse compression, the first detector pulse will only become shaped by the amplifier response, but the second detector output should now appear as the rectified form of Fig. 9(b). Small corrections can be made with Rv_1 and Rv_2 in the transmitter, until the best pulse shape is attained.

During the testing and subsequent operation, care must be taken to prevent any ultrasonic energy from transducer (1) reaching the grating directly, or from transducer (3) to transducer (2), as this may cause oscillation.

Performance

Any reasonable target gives a substantial signal well above the receiver noise which is only 10 mV. A man can be detected up to the maximum range allowed by the time-base speed, as discussed last month, whilst a table tennis ball gives an 0.25 V signal at about 4.5 m (15 ft).

The second detector will produce narrower pulses when operating in the pulse compression mode. Two small targets will appear to merge at 15 cm (6 in.) separation or less in the first detector, but the second detector allows the target separation to be reduced to about 3.8 cm (1.5 in.) before interference occurs. Fig. 10 shows the result obtained with two table

tennis balls about 6.3 cm (2.5 in.) apart. The top trace is from the first detector, the lower from the second detector. The displacement to the right in the latter case results from the greater overall delay introduced by the grating geometry. Thanks are due to Mr. K. F. Slater who initiated the project and who has kindly read the drafts, and to Mr. E. W. Houghton for his advice throughout, both of R.R.E.

The photographs are Crown Copyright, and are contributed by permission of the Director of R.R.E.

APPENDIX

Referring to Fig. 6; λ_1 is the wavelength of the beginning of the pulse, λ_2 is the wavelength at the end of the pulse. T is the pulse length and V is the velocity of sound in air.

At the top corner B,

$$d_1 = \frac{\lambda_1}{2 \cos \psi}$$

at the bottom corner A,

$$d_2 = \frac{\lambda_2}{2 \cos \theta}$$

For $d_1 = d_2$,

$$\frac{\cos \theta}{\cos \psi} = \frac{\lambda_2}{\lambda_1}$$

$$\theta = \phi + \psi$$

$$\therefore \cos \theta = \cos \phi \cos \psi - \sin \phi \sin \psi$$

$$\therefore \frac{\cos \theta}{\cos \psi} = \cos \phi - \sin \phi \tan \psi = \frac{\lambda_2}{\lambda_1}$$

Since ϕ is the beamwidth of the transducer and is known, ψ , θ and d can be found.

Also

$$a - b = TV/2$$

and

$$b/a = \sin \psi / \sin \theta$$

from which a and b may be found.

Anti-Collision Radar Aid

An interesting feature of a new anti-collision radar designed by Decca is a relative motion marker system that enables potential collision risks to be evaluated by making it possible to see simultaneously both the true and relative movement of other vessels in an encounter. Up to five relative motion markers can be used simultaneously to monitor separate collision risks. The markers are "painted" continuously by an inter-scan technique and are independent of the rotating main scan "paint" of the radar picture. Each marker is a 25mm-long straight line with a bright spot at one end that can be used to position the marker on an echo at any point on the display. All markers extend inwards towards "own ship" from the bright spot, and once set, remain fixed at the same range and compass bearing to "own ship", moving with it across the true motion display. If a marker is positioned on an echo, a collision risk exists if the echo closes "own ship" along the marker line of constant bearing.

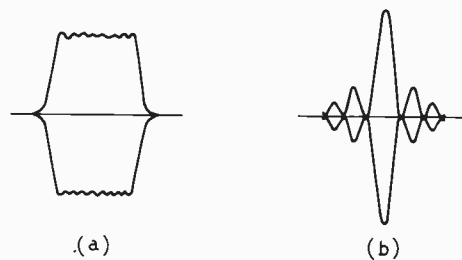
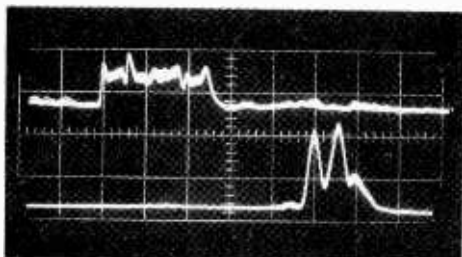

Fig. 9. Envelopes of the receiver waveforms.

Fig. 10. Echoes from two table tennis balls 6.5 cm (2.5 in.) apart. Upper trace detected before grating and lower trace detected after grating clearly showing the separate targets. Sweep speed 0.5 ms/cm vertical sensitivity 1 V/cm.



Combating Television Interference

Construction details of a simple notch filter designed to reduce interference from Continental television stations with Band 1 reception

Interference from more distant television stations occurs mainly during the summer months of June, July and August when sporadic E intensive conditions follow a day-time pattern of activity. A comprehensive report on the subject by the B.B.C. shows that interference was most serious in June 1966, when all Band 1 services were affected. Most viewers suffered from picture disturbance to some degree, ranging from noise patterns to breakup, usually accompanied by vision-on-sound "buzz" or foreign speech. The degree of interference during the summer of 1967 showed a reduction compared with 1966 although it still continued to be serious.

The receivers most seriously affected were those operating on channel 2 (51.75MHz vision carrier) and in consequence the Post Office Engineering Department has developed a simple form of notch filter for use on channel 2 receivers, with an insertion loss at 49.75MHz of over 30dB and a 6dB insertion loss at ± 1 MHz away from the reject frequency. Examples of the filter were tested at Redruth, Cornwall on the channel 2 signal from North Hessary Tor transmitter. Interference which previously completely obliterated the picture was reduced by the filter to a perceptible but tolerable pattern. Although sporadic E interference mainly affects channel 2 it also affects channel 1, to a lesser extent, and the filter which is described could be modified for use on channel 1. Known transmissions propagated by sporadic E in channel 1 are only slightly removed from vision carrier frequency, therefore use of the

filter here would degrade picture quality.

The sporadic E filter is basically a bridged-T filter constructed as shown in the photograph. The prototype was constructed for a frequency of 49.75MHz. Readily obtainable components are used throughout and the filter can be fitted into any convenient small metal box, e.g. a tobacco tin.

The coil consists of 12 turns of 20 s.w.g. copper wire, close wound on a pencil and evenly spaced to cover a length of 0.8 inch. The coil is tapped at 5, 6 and 7 turns. By compressing or expanding the coil the filter may be tuned to frequencies lower or higher than the nominal design frequency. A 1-inch 2BA screw is used as a coil slug and this enables a tuning range of approximately 1MHz to be obtained. In the prototype filter a Lektrokit tag strip was used but other types of tag strip having 5 insulated tags and 2 earth tags may be suitable. The 27-pF capacitor is a Radiospares tubular ceramic, 750V d.c. working, tolerance $\pm 10\%$. The 250-ohm carbon potentiometer can be any miniature component such as a Radiospares preset control.

Tuning procedure

Tuning the filter to provide maximum attenuation at the required frequency is a simple procedure but requires an accurate signal source. Two methods are described, one using an accurate signal generator and valve voltmeter, the other using a receiver tuned to Test Card D. The signal generator will require a setting accuracy of ± 2 kHz, or better, and an r.f. output of 100mV or more. When correctly adjusted the attenuation at the centre frequency of the filter will be approximately 55dB. Set the generator to the required frequency, in this case 49.75MHz, and connect to the filter input. The output of the filter should be terminated in a 75-ohm non-inductive resistor with the valve voltmeter connected in parallel. Increase the output of the signal generator until a convenient half scale reading is obtained on the valve voltmeter. Adjust the coil slug for a minimum reading, increasing the generator output as necessary. Now adjust the potentiometer to reduce the reading still further. Slight interaction may occur between the coil and potentiometer adjustments.

If a signal generator and valve voltmeter are not available, the following simple tuning procedure can be used in conjunction with

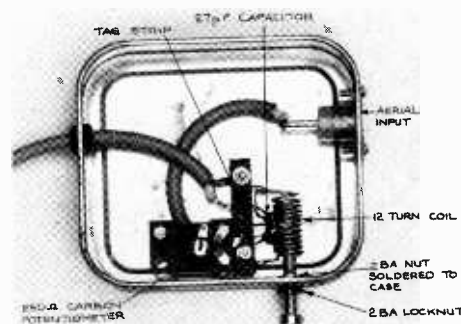

Appearance of the prototype filter unit.

Test Card D, displayed on a television receiver. Insert the filter into the aerial feeder of a television receiver which has been correctly adjusted to display Test Card D on channel 2. Carefully adjust the coil slug until the 2MHz frequency grating is as faint as possible, then adjust the potentiometer until the 2MHz grating disappears or is severely attenuated. Recheck adjustment of coil slug. The filter is now adjusted to provide maximum rejection at 49.75MHz. If it is desired to use the filter at other frequencies, small adjustments to the coil slug will not seriously reduce the notch attenuation but if the tuning point is varied by more than 0.2MHz the potentiometer will require readjustment. Although the filter can be constructed without a case, detuning could be a problem when the filter is used in close proximity to metal objects and it is likely that interference will by-pass the filter.

To eliminate severe sound interference a tunable filter could be constructed but there is a danger that in the hands of unskilled users, the wanted vision or sound carrier would become notched-out.

Viewers in the Manchester area using the Holme Moss transmitter on channel 2, are advised to use the alternative service from Winter Hill on Band III if they are badly affected by sporadic E radiation.

Outline Specification

Reject frequency (Fr) normally	49.75 MHz
Insertion loss at Fr ± 25 kHz	> 35 dB
at Fr ± 0.25 MHz	> 15 dB
at Fr ± 1 MHz	> 6 dB
at 51.75 MHz	> 4 dB
at 48.25 MHz	> 5 dB

Long term stability to be better than ± 25 kHz:
 (1) In temperature ranging from 50 to 80°F.
 (2) When subjected to the vibration and bump tests described in B.S.2011, Parts 2E and 2F.

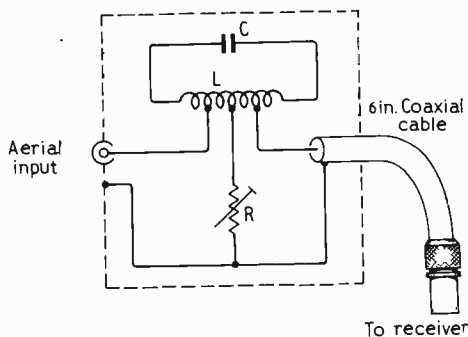

Circuit details of a simple bridged-T filter. C=27pF; L=12 turns, 20 s.w.g. wound to a length of 0.8in, outside diameter 0.4in, tuned by

$$\text{brass slug; } R = \frac{Q}{4 \omega C} \approx 150 \Omega$$

New Products

Wide Range Oscillator

Marconi Instruments Ltd, offer a new low-cost transistorized wide-range oscillator, TF 2103. Frequency coverage is 10Hz to 1MHz in five ranges selected by push-buttons. Scale accuracy is $\pm 3\%$, and the attenuator settings cover the range 2.5mV full scale to 2.5 volts. Output amplitude is 2.5 volts r.m.s. maximum on sine and square wave. On the 2.5mV, 25mV and 0.25V ranges the output impedance is 600Ω . At the maximum output of 2.5 volts the output impedance is typically 100Ω . The signal source is a Wienbridge variable-frequency oscillator. This is followed by an inverter/amplifier when sinewave output is selected, but by a Schmitt trigger circuit for square waves. The signals are finally applied to a complementary emitter follower stage and then through an attenuator to the output terminals. Amplitude stabilization is provided by thermistor-controlled negative feedback. The instrument is normally battery operated, but an



interchangeable mains power unit—TM9808—is available, priced £7 10s. The weight of the oscillator, including batteries, is only 2.1kg. The unit costs £35. Marconi Instruments Ltd., St. Albans, Hertfordshire.

WW 308 for further details

Versatile Edge Connector

The McMurdo Instrument Co. are marketing an edge connector strip facilitating connections to printed wiring boards. The moulded strip, containing 33 terminals, can be cut to convenient lengths of not less than four terminals. On one face of the square-sectioned moulding are contact tails in two rows at a pitch of 5.08mm (0.2in) and with the same spacing between rows. These fit through holes at similar spacings on the board for soldering to the printed wiring. The third face has a dual role. Two rows of tags suit AMP "Faston" connectors (No. 160303-1 and 150631-1) or can be used with a mating socket. This is also supplied to make up 33 connections or it too can be cut. The socket can be fixed to cabinets, racks, etc. by means of end brackets which are simply slid over

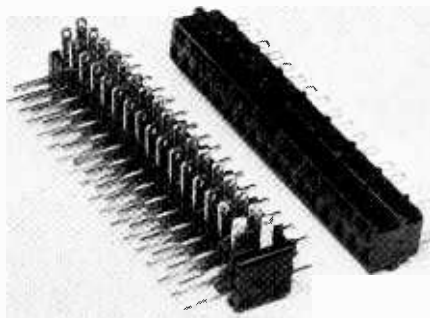

the ends of the moulding. Polarizing keys can be fitted to prevent incorrect insertion. The proof voltage is 1500V. Maximum current rating with the mating socket is 3A per contact, the resistance being 5 milliohms maximum. McMurdo Instrument Co., Rodney Road, Portsmouth, Hampshire. WW 307 for further details

Portable 10MHz Oscilloscope

Bandwidth of d.c. to 10MHz (20Hz to 10MHz a.c.) and a calibrated voltage range of 2mV to 50V per division are features incorporated in a new oscilloscope by Philips of Eindhoven which sells in the U.K. at £125 including import duty. Using silicon transistors, the makers claim that their instrument, model PM3200, represents a breakaway from traditional circuitry. Instability, noise and drift are virtually eliminated in the new amplifier design and attenuator balancing is automatic. Timebase speed is variable from 0.1μ sec/div to 0.5sec/div in 21 calibrated steps with an accuracy of $\pm 5\%$. Higher sweep speeds are employed in preference to horizontal magnification to give a brighter face at fast writing speeds. Pre-selected trigger switching makes for simple operation. Us-

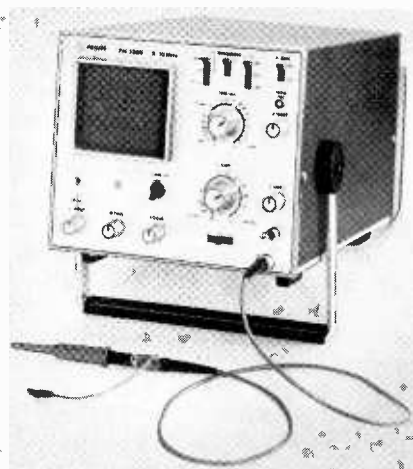

able screen area is 6×7.5 cm with 8 vertical and 10 horizontal divisions. Dimensions of the PM3200 are $17.5 \times 21 \times 33$ cm and its weight is 5.3 kg. Operating power can be drawn from a.c. mains, a 24V d.c. supply or an optional rechargeable battery pack attached to the rear of the instrument. Philips model PM3200 is marketed in the U.K. by M.E.L. Equipment Co. Ltd., Mancr Royal, Crawley, Sussex.

WW 303 for further details

Sound Level Meter

A second generation sound level meter from Cosmocord, type SLM3, is designed to meet B.S. requirements for the measurement of motor vehicle noise and industrial noise nuisance. It has a built-in "A" weighted frequency response giving the best correlation to subjective assessments of loudness. A high sensitivity 3-inch moving coil meter with selected fast and slow damping capabilities enables both peak and average levels to be recorded. Levels of 50–130dB in 7 overlapping ranges can be measured, and these can be extended down to 30dB by the use of an additional amplifier module type A8931. The instrument uses transistors throughout with a high degree of negative feedback and a 12dB overload capability, which ensures true r.m.s. indication and accurate reading of sounds of an irregular nature. An output socket is provided for a pen recorder and the removable microphone capsule can be used with an extension cable. Power is supplied by a PP3-type dry battery. The SLM3 measures approximately $10 \times 22 \times 6\frac{1}{2}$ cm and weighs 740gm. Basic price is £41. Cosmocord Ltd, Eleanor Cross Road, Waltham Cross, Hertfordshire.

WW 317 for further details

Moulded-encapsulation Triac

An 8-amp triac with moulded silicone encapsulation, type TA 7365 has been added to the range of thyristors and triacs by RCA. This new device is a

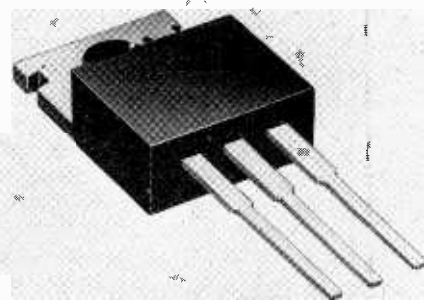

gate-controlled full-wave silicon triac fitted with three horizontal leads to facilitate mounting on printed circuit boards. The package design provides low thermal impedance which allows operation at high case temperatures and permits reduced heat sink size. Type TA 7365 is designed to switch on for either polarity of applied voltage with positive or negative triggering voltages to the gate. It has an on-state current rating of 8A at T_c of 80°C and repetitive off-state voltage rating of 400V. A 200V version is also available. Price of the TA 7365 is less than £1 for small quantities. RCA Great Britain Ltd, 36/38 Berkeley Street, London W.1.

WW 322 for further details

Small Pot Cores

High packing density is offered by a new type of ferrite pot core which can be fitted directly into printed circuit boards without additional hardware. Manufactured by S.T.C. Components Group, the new pot-core, type SM6, consists of two core halves and a bobbin with moulded-in ferrite pins of a type which permits mechaniza-

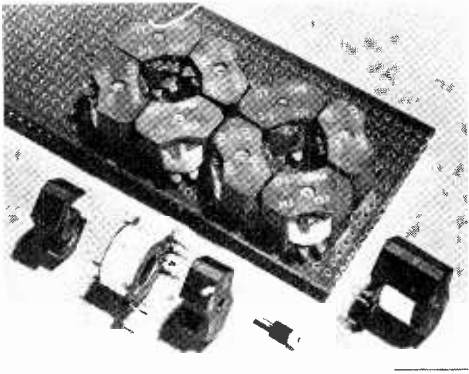

tion of the winding process. The terminal pins are 4.7mm long to suit $\frac{1}{16}$ -in printed circuit boards: when $\frac{1}{32}$ -in boards are used, the pins may be cropped. Bobbins are available with four or six pins as required which fit the standard printed circuit matrix of 0.1 in, the pin spacing being equal to the diagonal of a 0.1-in square in all cases. The pot core is assembled by cementing the lapped outer faces of the two core halves together, enclosing the wound bobbin. A four-pin core will fit into a space of 0.6 in square, and a six-pin into a space 0.7 in square. Maximum core height is 12.5mm. Four grades of ferrite material are available for the cores; two intended for inductor application and two for transformer use. For inductor use, the centre bosses of the core halves are ground and lapped to produce gapped cores and a special adjuster is fitted to ensure a smooth adjustment characteristic. The ungapped cores include materials with a very high effective permeability and are intended for use in untuned transformers where a high specific inductance value is desirable. Standard Telephones and Cables Ltd, Magnetic Materials Division, Edinburgh Way, Harlow, Essex.

WW312 for further details

Carbon-dioxide Laser

A single-frequency, single mode, carbon-dioxide laser as a stable reference oscillator for optical communications, range finding and radar applications has been introduced by Honeywell Controls. The device is of vitreous ceramic construction and uses an internal mirror system described as mechanically rigid and thermally stable. Frequency stability is quoted as being as high as one part in 10^{10} over a short term (0.1 sec) interval and one part in 10^8 over the long term (about 1200 sec). The device is tunable over about 10 transistions and has a diffraction-limited beam spread with an angular divergence of only 2.4



Wireless World, September 1968

milliradians. Power output is in excess of 1 watt. Honeywell Controls Ltd., Brentford, Middx. **WW 313 for further details**

Improved Trimmer Pots

Potentiometer manufacturers, Reliance Controls of Swindon, announce improvements in the design of their type WL18 wire-wound multi-turn trimmer potentiometer. The design changes have resulted in an improved electrical and mechanical performance. Pressure contacts have been eliminated and replaced with welded connections. Enamelled copper wire is now used for the resistance element, giving better temperature characteristics and lower inductance, while the use of epoxy resin to fix the resistance wire ensures that the element is mechanically sound. It can be supplied in a resistance range of 10 Ω to 40k Ω

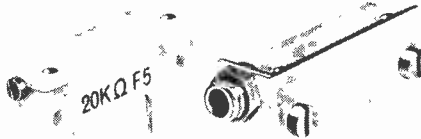

with $\pm 10\%$ tolerance. Wattage ratings are $\frac{1}{2}$ W at 20°C, derating to 0 at 85°C (whole element uniformly loaded); end resistance 1% to 5%. The insulation resistance is 1000M Ω at 500V d.c. and maximum working voltage 150V d.c. subject to the power rating not being exceeded. Reliance Controls Ltd., Swindon, Wilts.

WW 318 for further details

Discrepancy Key

From the Plessey Components Group's factory at Titchfield, Hampshire, comes a discrepancy key which has been designed for use on mimic diagrams including one-inch mosaics. It incorporates a five-position switch and has push and turn overthrow at each extreme. The switch contacts are gold-plated for low contact resistance and are

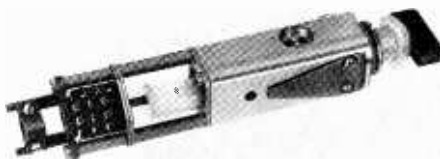

rated at 100mA, 50V d.c. (resistive). Operating temperature range is -10°C to $+55^{\circ}\text{C}$. The key is bush-mounted and as the frontal area does not exceed one sq. inch keys may be mounted on adjacent one-inch mosaic squares. The knob is designed for internal illumination, if required.

WW 320 for further details

12.4GHz Frequency Meter

Frequencies between 0.3 and 12.4GHz can be measured accurately, without manual tuning adjustments, by a new digital frequency-meter from Hewlett Packard. Apart from selection of one of two frequency ranges no further adjustments are necessary and the correct readout is obtained automatically. The instrument is made to display zero until it is locked-on to an input signal. This new meter, model 5240A, is a single package instrument using two recent developments; an automatic microwave frequency divider and an integrated-circuit counter. The frequency divider divides input frequencies up to 1.2GHz by a factor of 100 or, when the input frequency is in the 1-12.4GHz range, by a factor of 1000. The divided-down frequency is then applied to the counter. An 8-digit readout is provided, thus giving a resolution of 1kHz up to

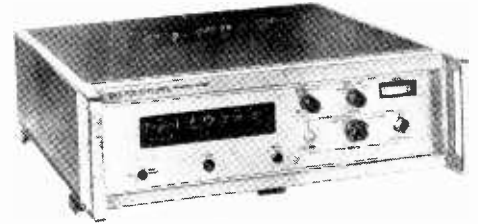

12.4GHz using a counter gate time of 1 second. Faster readings with reduced resolution are possible. Outputs in b.c.d. are provided for the operation of ancillary equipment. Signals within an amplitude range between 100 and 700mV are accepted at 0.3-12.4GHz input and an input level meter indicates if the unknown frequency signal is in the correct range. Cost of the 5240A is £2,127. Hewlett Packard, 224 Bath Road, Slough, Buckinghamshire.

WW 315 for further details

Strain Gauge Power Supply

Excitation from 4 to 20V d.c. at a stability of better than 0.5% for energizing resistance strain gauge networks or transducers based on strain gauges is provided by a new series of power supply and signal conditioning units marketed by Datametries Ltd. Available in either single- or six-channel form the units, type AP304-6, have floating stabilized d.c. supplies and are suitable

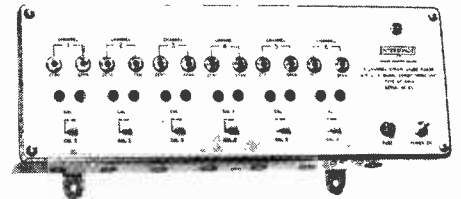

for energizing transducers based on a four-arm or two-arm configuration. In the case of two-arm bridges the bridge completion resistors can be accommodated on tag boards provided inside the units. Span and zero controls in the form of high resolution ten-turn helical potentiometers and voltage monitoring sockets are provided on each channel. The effective output of any associated transducers can be raised from millivolt level to 1V or more by the use of an optical plug-in amplifier. The amplifier module has a differential input with high common-mode rejection and provides sufficient output to operate meter movements, pen-recorders and other analogue display and recording devices. Datametries Ltd, Upton Road, Watford, Herts.

WW 309 for further details

A.C. Power Supply

A range of a.c. power supplies with ratings from 3 to 9000VA in single-, two- and three-phase versions has been introduced by KSM Electronics. Single-phase outputs of 0-250V are available at frequencies from 45Hz to 4.5kHz in nine ranges from 3 to 3000VA. High stability is featured, the

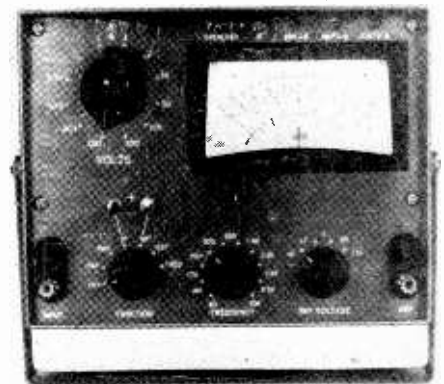

larger units providing an output regulation of 0.5% and distortion of 1% or better. Although some models are provided with alternative frequencies, optional parameters can be specified for all sizes. Specifications for the two- and three-phase versions are similar, with ratings up to 9000VA. KSM Electronics Ltd., Bradmore Works, Bradmore Green, Brookmans Park, Hatfield, Herts.

WW 310 for further details

Direct Reading Capacitance Meter

The Sprague Electric Company have produced a wide-range direct-reading capacitance meter Model 2W1 with a large meter with linear calibration readable to within 1% of full scale. There is no warm-up time. The scale of 300pF to 10,000μF in fifteen ranges is accurate to ±3% of full scale. The

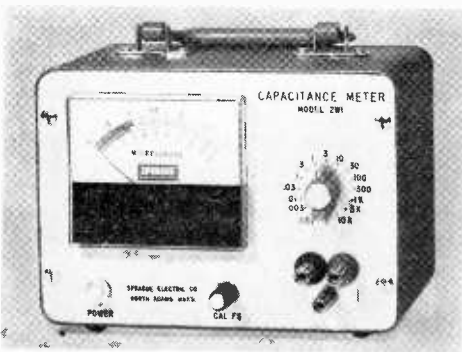

measurement time is a maximum of 1 second. A stepdown transformer is available to match the instrument to the 230V a.c. mains. Sprague Electric Company, North Adams, Massachusetts, U.S.A. WW 301 for further details

Trimming Potentiometer

A wirewound trimming potentiometer with a resistance of 10 to 50kΩ and a power rating of 1.25W at 50°C is new to the Contelec range. Operating from -55°C to 150°C and measuring 7 × 8.1 × 31.75mm the unit is available in two



types, 311 and 311-L, differing in their lead connections. W. Greenwood (London) Ltd., 21 Germain Street, Chesham, Bucks.

WW 305 for further details

Low-cost A.C. Calibrator

Low cost is the claim made for a portable calibration source for a frequency range of 10Hz-99.9kHz and voltages up to 500V, introduced into the Optimisation power supply range. The instrument measures 21 × 51 × 46cm and with it can be incorporated a ratio transformer to permit rapid adjustment of the output voltage after a single point calibration is made at a particular frequency. Operated in conjunction with an accurate a.c. voltmeter, this provides an inexpensive calibration system accurate to better than ±0.05%. Price of the basic unit called AC-50 CAL, is £904 including duty. The ratio trans-



former costs a further £417. U.K. distributors: Fluke International Corporation, P.O. Box 102, Watford, Herts.

WW 319 for further details

1kW Solid State Power Amplifier

Derritron Electronics have produced a 1,000-watt amplifier in addition to their 25-watt, 100-watt and 300-watt models. While mainly designed to operate as part of their electromagnetic systems up to 800lb vector thrust, the specifications permit a variety of other uses. Silicon semiconductors are used throughout and it is short- and open-circuit proof. For electromagnetic vibration applications effective testing down to 1½Hz is possible. An in-built variable frequency sine wave oscillator and control unit are included as standard. Full power



is available from 10Hz to 10kHz, reducing to 500 watts at 5Hz and below. Hum and noise are at 70dB below full output. Harmonic distortion is less than 1% from 10Hz to 10kHz. Full power operation is possible up to 100°C at least. Input is 1 volt into 100kΩ. Output is 15.8V 63.5A (0.25Ω). Cooling is by means of a closed circuit water system with a built-in water to air heat exchanger. Derritron Electronics Ltd., Sedlescombe Road North, Hastings, Sussex.

WW 326 for further details

Combined Soldering and De-soldering Tool

Mentor (W. Germany) have produced a combination de-soldering and re-soldering pencil called 'Vacubit'. Heat-up is immediate and re-soldering can be instantaneous. It runs off 240-volt mains, the 30W element heating the bit to 330°C. Available from the Welwyn Tool Company Ltd., Stonehills House, Welwyn Garden City, Herts.

WW330 for further details

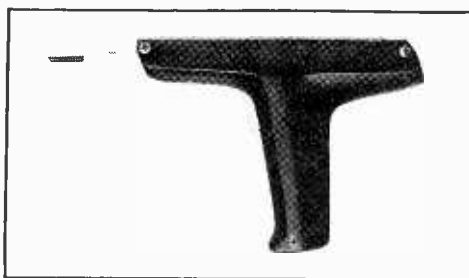

Wide-sweep Generator

A wide-sweep generator, model 159C, released by Kay Electric covers its spectrum in a single frequency sweep and incorporates the additional features of continuously variable sweep width and continuously variable centre frequency.

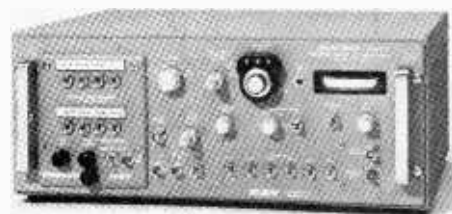

These features adapt the unit to a narrow sweep generator to cover video, i.f. and v.h.f. in a single tuning range. Frequency range is 1-300 MHz and sweep width 200kHz-300MHz. Metered r.f. output is 0.5V r.m.s. into 50Ω. Sweep modes are line lock, 0.01-1,000Hz manual, c.w. and external. Harmonic and spurious distortion is given as being greater than 30dB down. Kay Electric Co., Maple Avenue, New Jersey, U.S.A.

WW 304 for further details

I.C. for Hi-fi Stereo

A dual integrated-circuit pre-amplifier, specifically designed for high-fidelity amplification of low-level stereo signals has been announced by Moto-

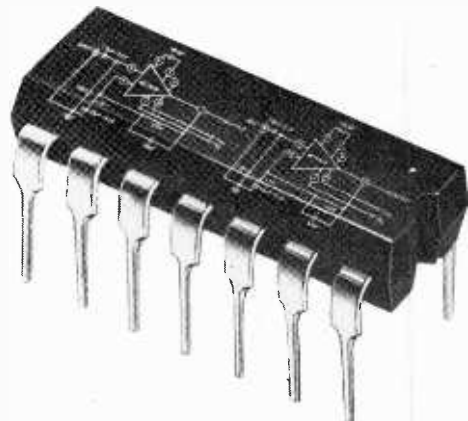

rela. The monolithic device, type MC1303P, features protection against accidental short-circuit, it being possible to connect together the output leads without harm to the device. A near-perfect matching of the frequency response of the two halves of the pre-amplifier is claimed. Channel separation is 60dB minimum at 10kHz with less than 0.1% total harmonic distortion at the minimum rated output voltage swing of 4.5V r.m.s. The MC1303P is capable of driving most tape leads directly without further amplification, a feature complemented by a minimum loop

voltage gain of 8000. Input bias current is $1\mu\text{A}$, input offset current $0.2\mu\text{A}$ and input offset voltage 1.5mV . Power dissipation is 300mW (d.c. maximum). Supplied in dual-in-line plastics package, the MC1303P costs £2 3s 2d each, in quantities over 100. Motorola Semiconductors Ltd, York House, Empire Way, Wembley, Middx. WW 316 for further details

Designer's I.C. Board

Cambion announce a new combination integrated circuit board for small production and bread-board experiments. This new board features a versatile cage-jack that terminates in a solder

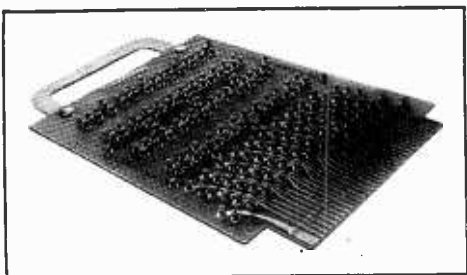

connection on the same side of the board providing front plane connection. The design gives ease and convenience of plugging dual-in-line circuits into the board, plus the dependability of soldered connections. Up to 16 i.c.s can be held at one time. Cambion Electronic Products Ltd, Castleton, near Sheffield, Yorkshire.

WW 324 for further details

I.C. Extractor

Cambion Electronic Products are offering, free-of-charge, an integrated circuit extractor designed as a convenience item for engineers and techni-

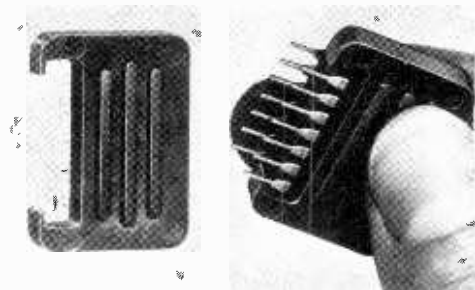

cians. It is a one-piece moulded plastics tool which allows the user to pull 14-lead i.c.s from their holders without danger of damaging the connectors. Applications for the extractor tool should be sent to Mrs Harrison, Cambion Electronic Products Ltd, Castleton, near Sheffield, Yorkshire.

High Vacuum Variable Capacitor

English Electric have added to their range of ceramic, vacuum, variable capacitors the type UC1000/10/125J. With a capacitance range of 25pF to $1,000\text{pF}$ and a maximum r.f. peak working voltage of 10kV , maximum r.f. current is 125A (r.m.s.) at frequencies up to 27MHz . The capacitor will work in ambient temperatures up to 55°C maximum with natural cooling. The overall length is 203.2mm and the diameter 115.9mm . English Electric Valve Company Ltd., Chelmsford, Essex, England.

WW 321 for further details

Thick Film Resistors

Thick film resistors produced by the cermet process of fusing glass and metal particles to a

ceramic substrate are now available from the Dubilier Condenser Co. They come in three types: RG-07 $1/4\text{W}$, rg-20 $1/2$ and RG-2 2W , and they are claimed to be extremely rugged and impervious to environmental extremes. In operation, the resistance change is typically less than 0.5% after 1000 hours at full rating. Dubilier Condenser Co: (1925) Ltd., Ducon Works, Victoria Road, North Acton, London W.3. WW 331 for further details

Single Decade Counter

Small size, high speed, electrical read-out and remote setting to zero are the primary features claimed for the E.N.M. single decade counter module. It is only 6mm wide and has a count frequency of 50Hz . Internal contacts enable groups of any number of digits to be driven in parallel or in series. The nominal count pulse length is 10ms at $\pm 10\%$ rated voltage. Reset pulse length is 200ms at nominal voltage. Power

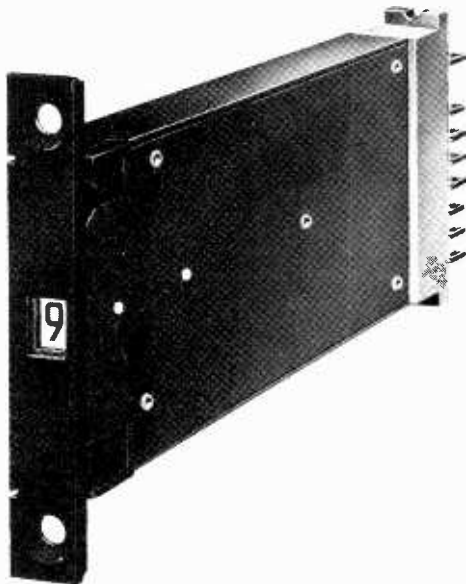

consumption under normal operation is 3W . The black-on-white figure appears in a black front plate which measures 43mm high \times 6mm wide. English Numbering Machines Ltd., 25 Queensway, Enfield, Middlesex.

WW 302 for further details

Low-noise Amplifiers

The AIM Electronics system 5 lock-in amplifier range, for measuring signals "lost" in overwhelming noise, has been extended by the introduction of three new low-noise amplifier modules. These new amplifiers may be used to replace the general purpose low-noise amplifier model LNA133. One of the new modules, the LNA133A has a differential input; useful when the sensing element cannot be isolated electrically from the experiment and a large unwanted signal is present on both signal wires. This unit has a noise figure of better than 3dB , a $300\text{-k}\Omega$ differential impedance and 70dB common-mode rejection. The other modules, LNA209 and LNA209A, both use f.e.t. input stages and have an input impedance of $100\text{M}\Omega$. The LNA209A has a differential input facility with common-mode rejection of 70dB . AIM Electronics Ltd, 71 Fitzroy Street, Cambridge, Cambs.

WW 311 for further details

Charge Amplifier

A new calibrated piezo-charge amplifier, particularly suitable for quartz crystal transducers but which can also be used with piezo-electric transducers of the ceramic type, has been introduced by Vibro-Meter of Switzerland. The amplifier, type TA-3/C, employs f.e.t.s and provides a sensitivity calibration which is independent of input

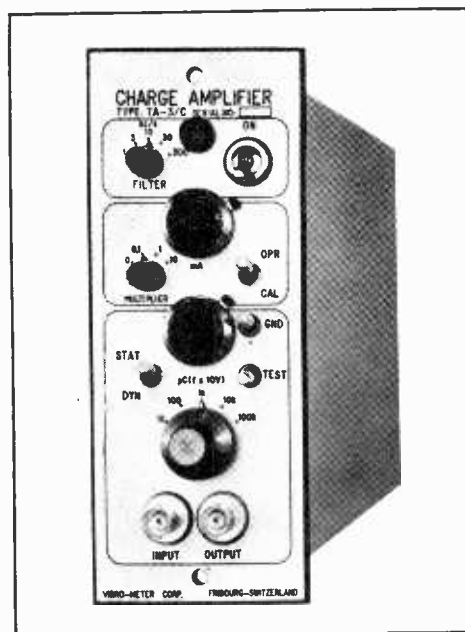

cable length. Three amplifier stages comprise a high-impedance f.e.t. input stage, a high gain main amplifier providing 10V , 10mA output, and a galvanometer driver amplifier providing 100mA into 40Ω . Calibration is achieved by adjusting the sensitivity of the c.r.t. Operation is from 240V a.c. mains via a built-in stabilized power unit. Frequency response of the TA-3/C is $0\text{--}300\text{kHz}$ (rise time $1\mu\text{s}$) with switched filter for 1, 3, 10, 30 and 300kHz , and the time constant on dynamic position is adjustable between 100s and $0.1\mu\text{s}$ (e.g. pressure signals can be differentiated). British Office: Vibro-Meter, Haletop Civic Centre, Wythenshawe, Manchester 2.

WW 314 for further details

R.F. Power Monitor

Series 4110 r.f. wattmeter from Bird Electronic is a pocket-size instrument for monitoring transmitters working in the frequency range $2\text{--}175\text{MHz}$. It is designed for insertion into coaxial transmission lines for the measurement of forward or reflected power and is available in three versions: model 4111 covering $25\text{--}175\text{MHz}$ with power ranges of 150W forward and 15W reflected; models 4112 and 4113 covering frequencies from $2\text{--}30\text{MHz}$ with power ranges of 200W and 1000W forward, and 20W and 100W reflected, respectively. Accuracy is $\pm 5\%$ of full scale. Price of the 4110 series is £59 plus duty. Bird Electronic Ltd, 33A High Street, Ruislip, Middx.

WW 323 for further information



World of Amateur Radio

OSCAR News

Project OSCAR Inc. of California (the group responsible for orbiting satellites carrying amateur radio equipment) do not expect to be able to arrange the launch of the Australis satellite until some time later in the year. The Australis satellite was constructed at Melbourne University, passed all its tests some time ago and is now reported 100% efficient on all its functions. The European satellite constructed in Germany is at present undergoing alterations in West Germany and is expected to be returned to California shortly. The next United States OSCAR is to be of the translator type, capable of receiving on 2 metres and retransmitting on 10 metres. It is expected to be completed early in 1969.

Earth-Moon-Earth Contacts

Chelmsford amateur, Peter Blair (G3LTF), received 1296-MHz signals, via the moon, from the Californian amateur station WB6IOM on 1st June. Within two minutes of the first transmitting cycle commencing WB6IOM was audible at Chelmsford at 4dB above the noise in a 100 Hz bandwidth, rising to 7dB at times, the frequency being within 500 Hz of the predicted spot, even allowing for doppler shift. Signals from WB6IOM were copied for two hours by G3LTF who later had the satisfaction of knowing that his own signals had been pen-recorded at WB6IOM. Subsequently the pen recorder tapes were sent to him by air mail. The transmitter used at G3LTF ran at 150 watts input into a 15-ft dish. The U.S. amateur used 500 watts and a 10-ft dish.

European Band Plan

To avoid misunderstanding it is felt desirable to draw the attention of all radio amateurs to the voluntary band plan which was adopted at the I.A.R.U. Region I Division in Opatija, Yugoslavia, in May 1966.

The plan is as follows:

Band (MHz)	Emission
3.5 - 3.6	c.w. only
3.6 - 3.8	c.w. and phone
7.0 - 7.04	c.w. only
7.0 - 7.1	c.w. and phone
14.0 - 14.1	c.w. only
14.1 - 14.35	c.w. and phone
21.0 - 21.15	c.w. only
21.15 - 21.45	c.w. and phone
28.0 - 28.2	c.w. only
28.2 - 29.7	c.w. and phone

The original plan was proposed by the R.S.G.B. in 1949 and has remained basically unchanged since. The present plan recommends that radio-teleprinting be confined to around 14190 kHz.

Yugoslavian Society Reshuffle

Following a recent announcement of changes in the hierarchy of the Czechoslovakian National Society, comes the surprise news that Janez Znidarsic (YU1AA), was replaced at the national conference in Belgrade on May 18, as President of the Yugoslav National Society (S.R.J.) by Bogdan Trgovchevich. At the same meeting Ferid Suman (YU1AF), was replaced as secretary of S.R.J. by Jablanovich Alexandar (YU1AY). Both Mr. Znidarsic and Mr. Suman had represented S.R.J. at numerous I.A.R.U. Region I conferences and the former has been a member of the executive committee for many years. Mr. Znidarsic has been made an honorary life member of S.R.J. an honour he now shares with only one other person, Mr. Nakichenovich (YU1A), who opened the 1966 I.A.R.U. conference in Opatija. Mr. Suman will continue to act as I.A.R.U. liaison officer.

Canadian Shock

Without any prior warning or discussion the fee for a Canadian amateur transmitting licence was increased four-fold on April 1st, from \$2.50 to \$10.00. The peremptory manner in which the announcement was made has been severely criticized in Canadian amateur radio circles.

The 1968 Olympic Games

In addition to the use of the distinctive prefixes 4A1, 4A2 and 4A3 in place of the normal XE1, XE2 and XE3 prefixes during the 1968 Olympic Games, the Mexican national society, L.M.R.E., is offering a special diploma to any amateur who submits proof of having worked at least 68 different Mexican stations during the year. Claimants must show that they have contacted stations in each of the three Mexican districts, XE1/4A1, XE2/4A2 and XE3/4A3. Claims should be sent to L.M.R.E., Post Box 907, Mexico, D.F., to arrive not later than March 31st, 1969.

Sensible Sped

During recent months some U.K. amateurs have received a letter from the G.P.O. pointing out that, in accordance with the terms of their Amateur (Sound) Licence, they are

required to transmit their call sign at a speed not exceeding 12 words per minute—a requirement laid down when the new (sound) licence was introduced during the mid-50s. Presumably they had been signing-off their transmissions at speeds in excess of that speed. Following protests by the R.S.G.B. that Morse proficiency should be encouraged, the Post Office has decided that call-signs may be sent at a speed not exceeding 20 words per minute. Good sense has thus prevailed.

U.S. Interference Bill Passed

The United States Senate recently passed and sent to the President a bill which will permit the Federal Communications Commission to regulate the manufacture, sale, shipment and use of incidental radiation devices capable of causing interference to radio communications. Passage of the bill is an important first step in the U.S. towards reduction of spectrum pollution by electric motors, car ignition, electric signs, heating devices and the like.

I.A.R.U. Region III Division Formed

Among the decisions reached at the inauguration of an I.A.R.U. Region III Division in Sydney, Australia, was one to the effect that a board of directors should be appointed (one from each of the national amateur radio societies present at the inauguration) to administer the affairs of the division. The directors so far appointed are T. Clarkson (ZL2AZ New Zealand), E. Asistores (DU1EA Philippines) and J. Battrick (VK3OR Australia). The president of the I.A.R.U. (R. Denniston, who presided at the conference) was also appointed a director. The next conference of Region III societies is to be in Tokyo in 1971.

Knokke Convention

The 4th Annual International Amateur Radio Convention organized by the Knokke Group of the Belgian National Amateur Radio Society (U.B.A.) will take place in the Casino at Knokke during the weekend September 13-15. A full technical and social programme has been arranged, full details of which can be obtained on application to M. Lucien Vervarcke (ON4LV), Lippenslaan 284, Knokke 1, Belgium.

B.A.T.C. Convention

The annual convention of the British Amateur Television Club will be held in the I.T.A. Suite, 70 Brompton Road, London, S.W.3, on Saturday, September 14, commencing at 10 a.m. Admission will be free and a cordial invitation is extended to those interested in amateur television to attend the convention which will feature a display of members' exhibits. Full details of the final arrangements can be obtained from D. S. Reid, 71A Rose Avenue, Brentwood, Essex.

Cornish Beacon Active

Beacon station GB3CTC is once again active on 144.1 MHz beaming north-east from Truro, Cornwall. W. D. Old (G3CZZ), 7 Trelawney Road, Camborne, Cornwall, who maintains the equipment will be glad to receive regular reports on the reception of signals from the beacon.

JOHN CLARRICOATS G6CL

Answers to "Test Your Knowledge"—4

Questions on page 320

1. (c). Johnson or thermal noise is present in all conductors due to the random thermal movements of the carriers and can only be reduced by reducing the temperature.

2. (d). An unsuppressed ignition system can radiate with substantially constant field strength up to frequencies of 1000MHz or more. Normal suppression techniques are not effective at frequencies much above 100MHz.

3. (b). The more important forms of unavoidable noise are "white".

4. (d). The root mean square thermal noise voltage is $\sqrt{4kTB}$, where the symbols have their usual meanings; hence the maximum power, which will be delivered to a load of resistance R , is $4kTB/4R = kTB$.

5. (d). A pure reactance produces no noise.

6. (a). There will always be a net flow of noise power from the hotter resistor to the colder whatever their values. This is in accord with the second law of thermodynamics.

7. (d). The optimum emitter bias current for low noise operation is much smaller than that used when noise generation is unimportant.

8. (c). Partition noise, together with a relatively low value of conversion conductance, makes the hexode a very noisy valve.

9. (d). The exact value required depends on how much noise is generated in the input circuit and how much in the first amplifier.

10. (a). It should be noted that in noise figure specifications the noise temperature of the source is usually assumed to be 290°K. Solution (b) is the "excess noise figure".

11. (c). By adding T_n to the noise temperature of the source we get an immediate indication of the noisiness of the system. Thus the output signal-to-noise ratio will be $W_s/k(T_s + T_n)B$ where W_s is the available signal power from the source and T_s is the source noise temperature. If the source noise temperature is 290°K then the equivalent noise temperature of the amplifier is related to the noise figure (F) by $T_n = 290(F - 1)$.

12. (d). It is roughly equal to the temperature of the objects "seen" by the main lobe of the aerial beam (so long as those objects behave as "black body radiators" in the frequency band concerned). Thus looking at the sun the noise temperature will be at least 8000°K. At some frequencies looking into space the noise temperature can be as low as 2 or 3°K.

13. (c). The i.f. amplifier contributes little to the total noise, so that increasing its sensitivity will amplify signal and noise alike.

14. (b). In a suppressed-carrier double-sideband system detection causes an increase in s/n ratio. If the carrier is present, however, its power is converted to d.c. and lost so that the s/n ratio decreases.

15. (b). The other three reasons quoted have some effect.

16. (a). In theory, using pulse code modulation, it is possible to receive signals with negligible error however low the signal-to-noise ratio, provided the signalling speed is slow enough.

Wireless World, September 1968



BULGIN SWITCHED LEGENDED INDICATOR UNITS

LEGENGING TO CUSTOMERS' REQUIREMENTS IN ANY LANGUAGE

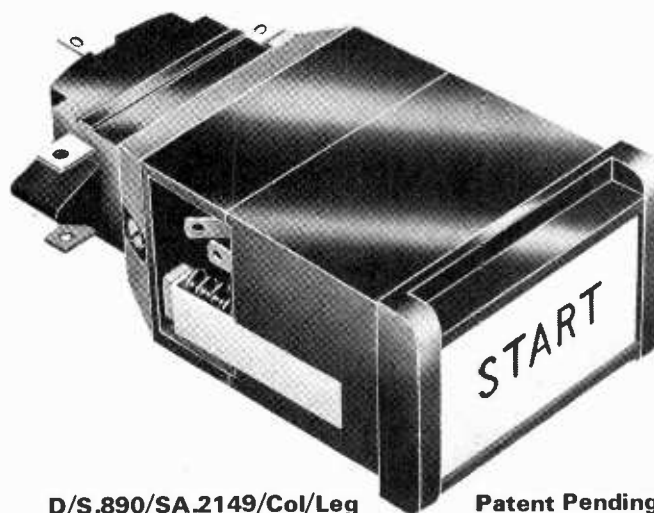

D/S.890/SA.2149/Col/Leg

Patent Pending

- ★ Assembled (or disassembled) from front of panel.
- ★ Multiple units can be mounted vertically into a single panel cut-out.
- ★ Pull-off button assembly gives easy access to the two lampholders.
- ★ Independent, isolated, lamp connection.
- ★ Legended to customers' individual requirement, choice of five legend colours.
- ★ Secret-unit-lit or permanently visible legends.
- ★ The legend area may be divided into two independently illuminated areas.
- ★ Choice of switch units, which can be replaced if necessary.

ELECTRICAL & MECHANICAL DATA

LAMPS: 2 L.E.S. (B.S.98/E.5) cap lamps 1.5-24 Volts, 1.5 Watt per lamp max. SWITCH DATA: D/S.890/SA.2149/etc., D.P.C.O. Push-Push (successional) Action rated 2 Amps at 250 Volts A.C. 1 amp at 250 Volts D.C. D/S.890/SA.2432/2/etc., Twin S.P.C.O. biased push action. 8 Amps (subject to life expectancy) at 250 Volts A.C.

APPROXIMATE DIMENSIONS:

Panel Hole: $1\frac{3}{8}$ " (34.9mm.) \times 1" (25.4mm.). Max. Panel: $\frac{3}{16}$ " (4.8mm.). Projection from Front of Panel: to front $\frac{1}{4}$ " (6.4mm.), to rear $2\frac{9}{16}$ " (65.1mm.). Panel Area Occupied: $1\frac{1}{2}$ " (38.1mm.) \times $1\frac{1}{16}$ " (27.0mm.). Legend Area: $1\frac{1}{4}$ " (31.8mm.) \times $\frac{3}{4}$ " (19.1mm.).

DRAWING AVAILABLE TO BONA-FIDE MANUFACTURERS

A. F. BULGIN & CO. LTD., BYE-PASS ROAD, BARKING, ESSEX.
TELEPHONE: 01-594-5588 (12 LINES) Private Branch Exchange.

WW-118 FOR FURTHER DETAILS

335

Real and Imaginary

by "Vector"

Rainbows and computers

'Somewe-e-ere over the rainbow . . .' carolled Miss Judy Garland in the long, long ago. She, with the help of her producer *et al.*, managed to get to the promised land at the end of it. Unfortunately, the rest of us don't seem to have acquired the knack.

As, for example, with nuclear power. If you are old enough you will remember the millennium we were promised. About tuppence a megawatt I think it was going to cost us and, for all I know, with green stamps thrown in. Came the dawn of the new era and we got our nuclear power stations; since when the graph of electricity charges has shot upward like a well-behaved interplanetary rocket.

Then, much more recently, we have had the same kind of promises about North Sea gas. Sometime in the unspecified future we're going to be able to cook at bargain prices. Anybody want to bet?

But before we get too cocky—are our pots any shinier than their kettles? I'm thinking in particular of our own brainchild the computer (to be strictly honest, an adopted brain-child, rather long in the tooth when we got him from his 19th century father, a certain Mr. Babbage). However, we took this retarded child, exchanged his cogs for electrons and—hey presto!—the end of the rainbow suddenly loomed very near.

What wonders the computer was going to perform! It was going to do all our work for us (we were going to get paid just the same of course) and henceforth our only worry was going to be that of how to fill in our spare time. The magic land of Oz was once again in sight.

Well? . . . Computers have been with us for a long time now. Are you putting in a two-hour week on full pay, just pressing a button occasionally to show the brute who's the boss? If so, kindly mail me the address of your recruitment officer. I'd like to join.

The Ministry of Technology has reported that 1967 was a record year for the delivery of British-made computers. It seems that we sold £96.1M worth. Now £96.1M, as Mr. Damon Runyan was wont to remark, is a considerable quantity of potatoes; so it can't be for lack of computers that the cost-of-living index obstinately continues its Himalayan trend. Thus the computer situation equates with the great nuclear power mystery and (I dare hazard) with the North Sea gas bubble.

One might have thought that events, from the Industrial Revolution onwards, would

have taught us a thing or two about prophesied millennia. We should know by now that these starry-eyed forecasts fall down because (inexplicably) they fail to take into account the Law of Cussedness, which states categorically that 'If anything can go wrong, it assuredly will'. As every engineer will testify, this Law is universal and fundamental; there are no exceptions to it.

Take the simplest case, in which a digital computer is installed to do routine, involved and tedious calculations of a repetitive nature, such as workpeople's wages and salaries. The innocent would naturally assume that, upon the takeover by computer, the whole of the accountancy staff who had formerly done these tasks would be whistled off to the Labour Exchange. Not so; the accounts people remain (they may even be augmented) while the advent of the computer brings to the organization a horde of new people; strange types who converse exclusively in ALMYEYE, the with it computer language of the moment. So the over all staff strength increases instead of diminishing.

While things are far from rosy in such a situation there is consolation in the thought that they might be worse. They can be, quite easily, because business life does not wholly consist of invariable repetitive problems; a goodly proportion of it is composed of awkward, unprecedented one-off queries. And this is where computer economics can take a decidedly steep dive.

Computer-aided design of electronic equipment, for example. The basic idea here is that you feed the system requirements into a computer and in milliseconds you are presented with the required design, complete with price and mean time between failures. I see that the Ministry of Technology is anxious to get the whole of the industry on to this bandwagon and to this end are encouraging the big boys with over-capacity in their computer departments to provide a service to their lesser brethren. This, as a paper exercise, looks perfectly splendid. But . . .

Suppose a small firm has one designer on its payroll. He may at present evolve his designs either by the time-honoured method of tearing a competitor's equipment to bits and introducing minor modifications (which saves a lot of time and bother) or he may elect to do it the hard way and start from scratch. In either event he will flog out a design on the back of an envelope and pass it

on for bread-boarding (or more probably, do it himself). Not particularly elegant, perhaps, but—note well—there is only one place where errors can be introduced, namely in the transition between brain and envelope.

The central computer philosophy, in theory, is much more promising. The data concerning the system requirements are sent to the computer by telephone, Telex or post and bingo! Back comes the answer. But wait!

Think now of the intermediate stages involved. Transition of the data from brain to paper. Errors possible. Transition to typescript. Errors possible. Transition from page to telephone. Ditto. Reception of data at other end of telephone. Very ditto. Further transition to typescript. Ditto. Then follows the various processing stages before the data get into the computer's innards in a form it can digest; this will account for about four more dittos. After that, the fruit machine churns out its answers and the communication system goes into reverse; all of which adds up to 18 to 20 places in which errors can be introduced. A benefit performance, in fact, for our old friend the Law of Cussedness. And, remember, the computer does not detect mistakes; a misplaced decimal point acts on it like a box of Purple Hearts on a human being or a hippie. It sends it as high as a kite.

Meanwhile, back at the small firm is there a vacant chair where the designer used to sit? There is not. There may well be two extra chairs whose occupants are wrestling with the corrections to the corrections to the corrections. And the designer is still there because some of the design problems the firm wants solved do not fit into any of the computer's programs.

The Achilles heel of the computer lies in the fact that you can't walk up to one, slap it on the abacus and say 'Listen Charlie, I've got a problem'. It's the complexity at the human/machine interfaces that can make computer exercises unprofitable, particularly if a one-off sequence, which calls for a new program, is involved. Sometimes the wisdom of Solomon (or a science-fiction computer) is needed to decide whether it is more economic to use a machine or a human, even when a computer lives just down the corridor and the number of transitions are thereby reduced. There is a real danger here because, with a machine available, there is a strong tendency to lean heavily and indiscriminately upon it. This develops into a sickness called 'magnetic-drum malaise', the chief symptom of which is a disposition to rush computer-wards with sums which could be more quickly (and much more cheaply) done on the now-despised desk calculator.

I am not so much knocking computers as the myths which have grown up around them. I have suggested that we do not discriminate sufficiently between what a computer will do and what it will do economically. But, economics apart, perhaps the most dangerous situation lies in the elevation of the computer to a status symbol. The manufacturing concern (or nation) which is known to be using computers on the grand scale now tends to be credited *ipso facto*, with the production of the best equipments. This can be true, but it can equally well be a complete nonsense.

TAPE RECORDER SURVEY

Tape Recording Practice

by Ralph L. West* B.Sc., F.I.E.R.E.

Just over 70 years ago Poulsen in Denmark was winding a yard or so of steel wire onto a grooved brass drum. His aim was to try to record signals that had come over the telegraph lines. The "Telegraphone" did work and was demonstrated at an engineering exhibition in Vienna in 1898. Franz Josef I, the first Emperor of Austria and Hungary, who was one of the V.I.P.s present, saw the device and his recorded voice—a little less than twenty seconds of it—is preserved to this day in the Danish State Museum. Little did Poulsen know what he had started! Though a few investigators experimented with the idea from time to time, it was not until the 1930s that any large-scale investigation was started or significant developments made. Almost all of this progress was in Germany, and independently in America, and was not disclosed until after the '39-'45 war. Since then progress has been very rapid.

In the field of entertainment tape is paramount. Nearly every radio broadcast either comes off tape or, if live, probably also goes on to tape for future use. Every gramophone disc made during the past fifteen years or so was made via a tape master. For better or for worse this technique, by stringing together all the takes without blemishes, now enables us to buy perfect musical performances. With the tape intermediary an orchestra can record its part of an opera while the soloists are on the other side of the world perhaps performing in a different opera. The voices can be added any time later and it is even possible for the principals to be changed at a later date for another issue of the record.

Large as the entertainment field of application has become, especially since television started using magnetic tape for recording programmes, the other uses—computers, machine control, data collection, etc.—are still by far the largest.

A reel of $\frac{1}{2}$ -inch wide tape contains about 10,800 billion magnetic particles, so it has a large information storage

capacity. Since these particles weigh only 148 grammes and the world consumption of the material at the present time is about 3,000 tons per annum, there must be a very great deal of information storage going on!

Professional and domestic machines

For audio applications tape recording falls into two categories, professional and domestic, though there is a large degree of overlap. The present heavy tax on tape recorders, however, may force on us a very clear dividing line. Basically they are one and the same kind of machine in function, layout and electronic circuitry, and their tapes are to a large extent interchangeable. The difference lies in the standard of performance. This is worth considering for a moment as any serious buyer must know what he is looking for and why.

The professional standard of performance for a tape recorder could be broadly defined thus: that the final reproduced material shall be indistinguishable from the original, as judged by our senses! To the student of law this will look pretty elastic. It is and it has to be. But indistinguishable to whom? And in what circumstances? Clearly a range of requirements, clearly a range of standards. Then cutting right across requirements and further widening the range is the ever-present parameter of cost. Of course, if the money available is too little then the project cannot go forward, for unless the machine reaches a certain minimum standard it is of no use at all for that job. Therein is a moral. Another important attribute, not specified but implied in the above definition, is that the machine must continue to operate to the same standard for a *reasonable* length of time—again an elastic standard. Some users may need it for only a few hours a week—no more than average domestic use. Others, however, may use it continuously eight hours a day, five days a week, plus overtime. This embodies a second important moral.

There are several other factors that make the professional machine very different from even a very good domestic machine. Professional work may necessitate the final product being a copy of a copy. Yet this third-generation tape must still reach the standard we have suggested. This necessitates not only using the best materials and extreme accuracy in manufacture but each machine will also require individual adjustment and rigorous testing. The domestic user, playing back his own recording (which is of course first-generation) and hearing comparable results, may wonder why professional machines need be so very costly. Another point that rarely bothers the domestic user is interchangeability of recorded material. Professionally a tape is seldom played back on the machine it was recorded on. Whatever machine it is recorded on and whatever played back on, it must always sound the same. Everything must therefore be within very close tolerances of the agreed

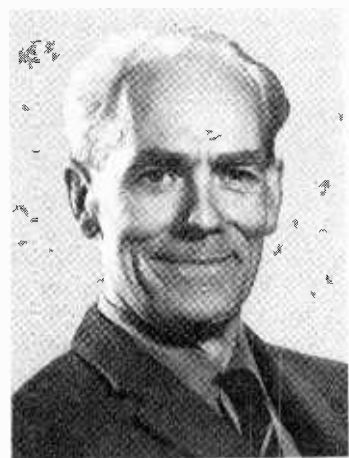

Ralph L. West was born in the north Midlands in 1912. After graduating in physics at what was then University College, Nottingham, he became a lecturer at Northern Polytechnic. He was a member of the original Radio Trades Examination Board and an examiner for several years. He has served on the I.E.R.E. Examinations Committee and on the Audio Committee. Whilst his work at the Northern Polytechnic covers a wide field, his primary interest has always been in high fidelity. Based on the principles enunciated by Voigt, he designed the Decca Corner Horn in 1949. He regularly lectures and demonstrates various aspects of the subject.

standards of speed, of frequency response and of level of recording, among other things.

One little bogey that often plagues serious tape recording is 'print through'—the strong magnetic field from a little patch of very loud signal will often induce a similar though feebler pattern into adjacent layers of tape. These feeble signals are often audible as echoes, especially if they coincide with quiet intervals. The one or two heard before the actual sound are called pre-echo; those after the loud sound post-echo. Storing the tape in hot conditions increases this in effect, and of course if such a tape is copied or turned into a disc the echoes are there for ever. The best way to minimize this trouble is to keep successive layers of tape as far apart as possible, i.e., use a thick tape. So professional workers always use the so-called standard tape. They therefore need larger reels, as well as for another reason that the machines usually operate at higher speeds. To handle all this tape quickly, tidily and under control at all times, pretty well all parts of the machine are bigger and better than the equivalent parts of the domestic machine, whose spools are rarely larger than seven inches in diameter and generally use the thinner long-play and double-play tapes.

Add to all this the fact that fewer professional machines are needed than domestic models, and they therefore cannot enjoy the cost reduction that large-scale mass production confers, and it is then not surprising that they cost about ten times as much as domestic machines doing basically the same job.

Interpreting published specifications

It is a source of some amusement to audio engineers and some little confusion to the layman that the published specifications of tape machines seem to show the really expensive machines as being inferior in performance compared to the much cheaper domestic machines. In fact it has been suggested that the claimed frequency response seems to be inversely proportional to the cost of the machine! This is a result of the high pressure salesmanship that is part of our economic system. Even if the advertising people do not actually tell technical lies they naturally make the most of the capabilities of their product. Let us particularize. A machine costing say £60 may claim a frequency response from 20Hz to 20kHz at 7½ inches per second while the £600 professional machine claims only 40Hz to 12kHz at the same speed. Where is the catch? There are several. What is the deviation from a flat response over that range? What is the distortion level and what is the signal-to-noise ratio (or background noise level)? Again the cheaper machine may claim wow and flutter figures at least as good as the better machine. It may even be possible to demonstrate these figures when everything is just right. The professional machine must never fall below its claimed performance any day with any tape it is given to use, or anywhere from the beginning to the end of the tape.

This does illustrate the morals we have suggested. That is, think, study carefully and ask advice if necessary before deciding. Ask the question 'Will the machine do what I hope it will do?' This applies at all levels, whether one is contemplating a £5 10s battery portable from the bargain columns of the daily press or a £3,000 studio machine.

The professional user generally knows what he wants and more often than not buys equipment with control or circuit details specially tailored to his needs. At the other end of the scale there are many people who buy on a mere whim, amuse themselves for a while and then lose interest.

Evolution in equipment design

For the more general user what does the present bewildering array of equipment offer and where does it stand in relation to

older machines? When tape recorders first appeared on the consumer market about 15 years ago they were produced generally with more enthusiasm than judgment. The whole thing looked easy—merely running a piece of tape from one reel to another past two or three magnetic heads and a few guide posts. The mechanical accuracy used in their manufacture was no worse or no better than that of the cheaper record players of the day. It was soon apparent that though tape recording side-steps the well nigh impossible contortions that the pickup stylus is called on to perform as it tries to follow a groove—with the two sides different in stereo—tape had its own problems. Tape is an elastic medium. Put crudely the problem is like trying to pull a piece of elastic at a constant speed over a nutmeg grater! There was an electrical problem, too. Feeble signals, from the microphone during recording and from the magnetic head during playback, had to be amplified without introducing hum or noise. They needed the kind of amplification then only met in professional and the more expensive high-fidelity equipment. This called for more valves and much greater care in design and layout compared with, say, a record player, which only needed about one tenth as much amplification. The valve manufacturers produced new valves like EF86 and ECC83 which were low-noise types and reasonably free from microphony. If one wanted to reduce noise still further then d.c. heating of filaments could be arranged.

Just because valves are going out and transistors coming in one should not look down on these older equipments. In fact, the writer has a 14-year-old machine that will still produce an almost professional-standard tape. Such equipments did the job to our requirements and, after all, the laws of nature haven't changed, so they are still as good as they were. Though our measuring instruments may tell us wonderful things about our new transistor amplifiers, unfortunately our ears do not always agree. Transistors inherently distort much more than valves and therefore need more complicated circuits to get the same performance. Their small size, permanence, low noise and current economy, however, make them formidable competitors—not to mention the instant start and the freedom from microphony. For the battery portable recorder one must certainly use an all-transistor design, otherwise weight and battery complications make it a far less practical proposition.

Tape versus disc

How does sound quality via tape compare with disc? This is a very difficult question. On a purely theoretical basis one could argue that since magnetic recording is done by an inherently non-linear process—the B-H curve—then tape is clearly at a disadvantage, as we can quite easily control the cutting of the disc with virtually perfect linearity. Furthermore, the modern disc has a finer grain or smoother surface than magnetic tape and so has an inherently quieter background. However, when one adds the difficulty the stylus has in following this complicated groove, which sooner or later gets dusty and worn, then the difference is not so large in practice. At professional tape level it is of course superior, and tape deterioration is generally negligible. This obviously must be so or disc manufacturers would not continue to use tape. Apropos tape background noise, this should in the future no longer give any trouble to professional users. Several schemes have been devised to process the signal before recording and restore it to normal on replay in order to reduce background noise. Basically this is an old idea and we already enjoy our good sound quality from l.p. discs and the f.m. radio service by these means. By boosting the higher frequencies beforehand and afterwards reducing them, we also reduce much of the audible background noise. It is not possible to do it as simply as this with tape, as we already have to boost the extreme top during recording for other reasons merely to break even.

UHER

the ONLY tape recorder for YOU...

4000 REPORT SERIES Three different models of the Uher 'Report' are now available:

4000 Report - L

As illustrated. Specification: 2 Tracks conforming to international standards-2; Tape reels diam.-5"; Tape speeds (ips) $\frac{1}{2}$, 1 $\frac{1}{2}$, 3 $\frac{1}{2}$, 7 $\frac{1}{2}$; Frequency range (cps) 40-4, 500/40-10,000 and 40-16,000/40-20,000; Dynamic volume range (db) 40 at $\frac{1}{2}$ ips, 46 at 1 $\frac{1}{2}$ ips, 50 at 3 $\frac{1}{2}$ ips, 52 at 7 $\frac{1}{2}$ ips; Wow and flutter (max \pm %) 0.2% at 7 $\frac{1}{2}$ ips; Recording mono; half-track; playback mono half-track; Power output one watt.

Monitoring via headphones or speaker; VU meter + three digit tape counter; tape stop-start remote control, collectorless motor controlled by 8 transistors; power supply from 6V, 12V, 24V car battery, from rechargeable accumulator or 5 flashlight cells 1.5 Volt; 17 transistors.

Inputs: microphone, radio, pick up 1V at 15 Kohms and 2V at 4ohms. Weight 6 lbs (approx). 121 gns.

4200 Report Stereo

Affording all the advantages of the successful 4000 Report-L in size, style and specifications—plus stereo. 146 gns.

4400 Report Stereo

Again with all the advantages of the 4000 Report-L—plus stereo and maximum economy of tape on four tracks without deterioration of reproduction quality. 146 gns.

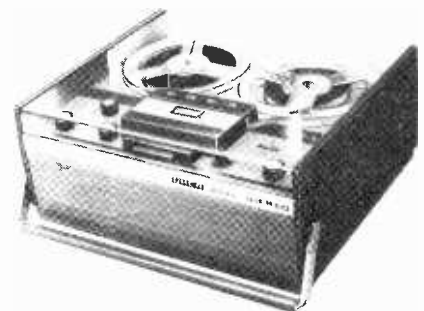

724 L Stereo

Specification: 4 Tracks conforming to international standards-4; Tape reels diam.-7"; Tape speeds (ips) 3 $\frac{1}{2}$, 7 $\frac{1}{2}$; Frequency range (cps) 40-14,000, 40-18,000; Dynamic volume range (db) 45 at 3 $\frac{1}{2}$ ips, 46 at 7 $\frac{1}{2}$ ips; Wow and flutter (max \pm %) 3 $\frac{1}{2}$ ips 0.2, 7 $\frac{1}{2}$ ips 0.15.

Recording mono and stereo; Playback mono and stereo; Power output. 2 x 2 watts; Microphone, radio, pick up inputs, output 1V at 15 Kohms and 2.8V at 4ohms.

Weight 20 lbs (approx.) 97 gns.

Recommended Retail Prices

DISTRIBUTED IN U.K. BY

BOSCH

The range of UHER tape recorders and accessories available in the U.K. satisfy the requirements of every amateur and professional enthusiast.

...when quality is your first concern

... always ask for UHER tape recorders and accessories. Quality is the simple, single aim behind their manufacture. Their production is also the sole pre-occupation of the UHER Company, whose specialisation has led to many outstanding developments, including the first application of printed-circuit techniques in tape recorder manufacture. For further details contact UHER Division, RHODES WAY · RADLETT RD · WATFORD · HERTS Telephone Watford 44233

BOSCH

has established a universal reputation for quality backed by continuous research, development and over 80 years of manufacturing experience. 85,000 BOSCH employees are universally engaged in the research, manufacture, distribution and service of BOSCH products. These include an impressive range of domestic appliances; radios; stereograms; tape recording equipment; automotive accessories and safety equipment; electric tools; hydraulics; language laboratory and closed circuit television systems... all of which are marketed in the U.K. by BOSCH LIMITED... a member of the BOSCH GROUP.

See the full range of Uher Tape recorders and accessories in the Elysee Suite of the Cafe Royal August 25-29.

WW-119 FOR FURTHER DETAILS

A scheme recently evolved by Dr. Ray Dolby makes it possible to reduce audible background noise by 10dB without producing any distortion or other odd noises that many earlier systems suffered from. The Dolby 'sound stretcher' is being taken up by many sound recording studios so we will soon have discs with even quieter backgrounds. The system is quite complex, as it separates the audio spectrum into several bands of frequency and treats each band differently. This is suited to the highest professional standards, of course, but a much simpler version does seem possible and may well come within the reach of at least the better types of domestic tape recorder.

Back at the domestic level, in the £100 range, one can record and play back, say, a radio programme with no obvious loss of quality. To reach this standard everything must be just right. The right tape for the recorder, the machine mechanically in good trim, correct input and output connections, and, most important, a high enough recording level just short of overloading on the peaks. The final sound is more likely to be limited by the loudspeaker than by the tape machine. At lower price levels, of course, one must expect a little less, but even then sound at least as good as that from a medium-priced record player should be possible. When it comes to making one's own live recordings, then rather more practice and experience will be necessary before really satisfactory results are obtained. It may also be necessary to graduate to a better quality microphone. A relatively cheap microphone that is perfectly satisfactory for speech and possibly recording bird songs may show up badly when trying to record an orchestra or a group of singers, for instance. It is instructive to realize that the most expensive microphone used today costs about 100 times as much as the cheapest ones!

The so-called pre-recorded tapes (why the pre?) are another

source of entertainment, and while they are nowadays vastly improved on the whole it is a pity that so many have appeared that are markedly inferior to discs. Without doubt many manufacturers seem to have tried to compete with discs on cost instead of producing something possibly a little more expensive but far superior to the sound from an ordinary record player with a worn stylus and dusty discs. The future for tape entertainment looks very much like settling down to the cassette. Several types are still jockeying for popularity but the small Philips cassette is not only gaining ground very rapidly but the equipment to handle it is improving so much that it is frequently difficult to believe one is only listening to a pair of stereo tracks occupying one half of an $\frac{1}{8}$ -inch wide ribbon of tape. Incidentally, it is arranged this way so that a mono machine will play the left and right tracks simultaneously to produce a mono signal. This is equivalent to eight tracks on a $\frac{1}{4}$ -inch ribbon of tape. One would not have believed this possible a few years ago.

Numbers of tracks

Another question often asked is: two tracks or four tracks? The man who aims to make the best possible recordings that his price-level of equipment can produce should without doubt follow the professionals and use two tracks on his $\frac{1}{4}$ -inch tape—that is, two separate recordings or one stereo recording. His recorded track width is more than twice that of the four-track machine. So he gains on at least three scores. His playback signal is larger—just over twice the voltage or 6dB. Noise is larger too but being a random quantity produces only twice the power—3dB. He therefore gains on signal-to-noise by over 3dB. For a given maximum loudness his background

SCOPETRONICS LIMITED

At the centre of our success is the SCOPETRONIC precision tape head used by Government departments and world famous manufacturers.

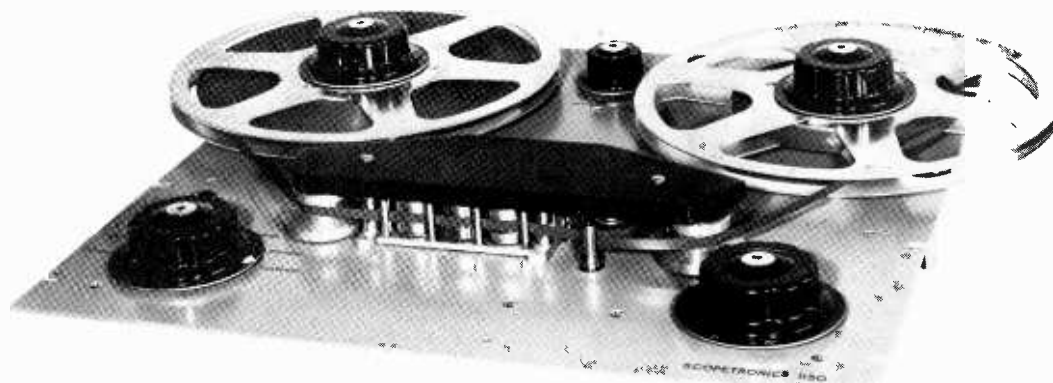

SCOPETRONICS LIMITED

Crown Works, Church Rd.,
Kingston-upon-Thames,
Surrey.
Tel: 01-546 1275/4135

Over the last 5 years the 1150 tape transport has become well known for its stability and rugged reliability. Those of our friends and customers who would like information about our new multi-track professional recorder—shortly to become available—should contact us without delay. There's sure to be a waiting list!

noise is therefore reduced by over 3dB. A 3dB change in sound level corresponds roughly to a 30 degree rotation of an average volume control and is quite noticeable.

This wider track recording is also not so sensitive to alignment errors when the tape is played on another machine with the head a little higher or a little lower relative to the tape travel. With quarter-track operation permissible errors are clearly half those for half-track working. The third factor generally shows up later as the tape wears and its edges possibly stretch due to rough handling. In a relatively cheap domestic machine a very short re-wind time proudly claimed is to be viewed with suspicion if one values one's tapes. A frayed edge will not sit snugly down onto the head and the resulting rapid fluctuations of signal level will produce an audible roughness which is much less with half-track working, of course. With quarter-track, in fact, gross wear and misalignment may make tracks one and four almost unusable with an old tape. This highlights again the very great accuracy needed in the little cassette machines.

An excellent compromise where separate recording and playback heads are fitted is to record with a two-track head and playback with a quarter-track head. Only the signal-to-noise ratio suffers a little. The other two troubles are almost completely sidestepped, and one can always play commercial recorded tapes, which are usually quarter-track, as well as one's own half-track tapes and other people's half- and quarter-track recordings.

Types of tape

A few words on the tape itself are relevant at this juncture. All tape, cheap and expensive, is made on expensive precision machinery and given its oxide coating in clean air conditions stricter than those in an operating theatre. The long band of tape several feet wide is then slit to an accuracy of a thousandth of an inch or so on another expensive machine. The instrumentation and computer people require a tape the thickness of which remains accurate to a micron or two and end to end is completely free from blemishes—otherwise there could be, say, a serious error in a bank account! Some of this tape is specially made as many applications give the tape a real towsing, continually starting and stopping, for instance, in times of three milliseconds. For audio professional work the requirements are not so exacting, though this too needs freedom from the tiny blemishes which result in 'drop-outs' or momentary loss of signal. Some of the professional audio tape has special coatings or special plastic bases. Substandard tape—most of it only very slightly below standard and often only substandard here and there—is sold at lower prices under various names or even no name. This tape is often a very good buy, provided a reliably consistent product is not expected.

As already explained, standard tape—the thickest—is best on the score of strength and freedom from print-through. It takes up more room, however, so playing time per reel is less, and being stiffer may not run smoothly in a small machine with only limited motor power. Generally domestic machines are better off with long-play tape. Small battery portables with their flea-power motors must have thinner and more flexible tapes. The very thin triple-play and quadruple-play will literally flow over their heads like a layer of varnish, while a standard-play tape would only bounce across like a piece of clockspring.

All the early tapes used an acetate base—the same material our photographic films are based on. This did tend to become brittle, especially in dry conditions, and was sensitive to changes in humidity and so has been largely superseded by p.v.c. But some users prefer it as breaks occur with very little stretching, leaving the repaired tape unaltered in length. The very thin tapes have become possible only with the introduction of polyester foil. This is immensely strong but early samples would stretch quite a lot before breaking. It suited the

ham-handed domestic user but embarrassed the professional. New film stretching techniques have been developed that endow the latest polyester tapes with as small a stretch as acetate tape. These, or something very similar, will probably take over completely in a matter of time.

Head design and magnetizing techniques

A new development has appeared recently, the so-called cross-field system, with claims great enough to make the more serious user a bit suspicious. The fact is we do not yet fully understand the mechanism of magnetizing the tape during the recording process. There are various theories, but most of our knowledge in this respect has developed empirically. We know, for instance, that it is necessary to mix a large radio frequency current with a smaller signal current in order to put the desired distortion-free magnetic pattern onto the tape. Just how this process works we are still uncertain.

In the past we have always mixed this r.f. current, or bias as it is called, with the signal current and fed the combined current to the record head. Now, probably prompted mainly by work done by Camras in America a few years ago, a number of manufacturers have investigated the possibility of applying the bias field with a separate head on the other side of the tape. Although there is as yet no agreement as to the precise mechanism involved, results are very promising and several machines are already available using one or other version of this general idea. The precise claim is of vastly improved recording of high frequencies, that is, of very short wavelength magnetic patterns. Evidence to date is most encouraging, and the enhanced high frequency response seems to be accompanied also with reduced distortion of the lower frequencies. This development will certainly improve the results at the lower tape speeds, even if it proves of less interest to professional workers with their higher speeds.

Another development struggling onto the market at the moment, but certainly a valuable one, is the hard ferrite recording head. From the very beginning nearly everyone has used Mumetal heads. This is a high purity nickel-iron alloy and is chosen as it produces less distortion than most other materials we might use. It is unfortunately relatively soft and magnetic tape is a good (?) abrasive, being chemically very similar to jeweller's rouge. The metal surrounding the microscopic gap in the recording head where the tape passes is very thin—a few thousandths of an inch wear and it is worn right through. Modern tapes are far less abrasive than some earlier ones, so head wear is generally only a worry after thousands of hours use and is only likely to be a serious concern to professional users. During this past 10 or 15 years, as our understanding of magnetism has deepened, we have been able to develop several non-metallic magnetic materials with outstanding properties. These are all very hard and stone-like and very resistant to abrasion. Most of them are unfortunately brittle and coarse-grained in structure, so can only be used satisfactorily for erase heads, which have much wider gaps. Now several new fine-grained ceramic magnetic materials have been developed that will polish at least as smoothly as glass. Heads of this material show negligible wear or change in properties during use. As with most things, once we have got down to mass producing them the price should fall and eventually be within the reach of the domestic market.

Very recently a stir was caused by the announcement of an entirely new magnetic coating of chromium dioxide by DuPont. It is being marketed under the name of Crolyn and has very superior properties, giving greater density of information than iron oxide. It is of immediate interest to video and computer users but could well revolutionize audio design by enabling much lower tape speeds to be used.

Ferrograph quality Ferrograph reliability Ferrograph fidelity plus a unique combination of 30 features Ferrograph New Generation Series 7



Available in Mono, and in Stereo with and without end amplifiers; with 30 features which market research has proved you, the user, want. Prices from £135 inc. P.T. Features include:

1. All silicon solid-state electronics with FET input stages and wide input overload margins.
2. Vertical or horizontal operation.
3. Unit construction: The 3 individual units i.e. tape deck, power unit and amplifier complex are mounted on a single frame easily removable from cabinet for service or installation in other cabinets or racks.
4. 3 motors (no belts). 3 tape speeds.
5. Variable speed spooling control for easy indexing and editing.
6. Electrical deck operation allowing pre-setting for time-switch starting without need for machine to be previously powered.
7. Provision for instantaneous stop/start by electrical remote control.
8. Single lever-knob deck operation with pause position.
9. Independent press-to-record button for safety and to permit click-free recordings and insertions.
10. 8½" reel capacity.
11. Endless loop cassette facility.
12. Internal loud speakers (2) - 1 each channel on stereo, 2 phased on mono.
13. 4 digit, one-press re-set, gear-driven index counter.
14. 2 inputs per channel with independent mixing (ability to mix 4 inputs into one channel on stereo machine).
15. Signal level meter for each channel operative on playback as well as record.
16. Tape/original switching through to output stages.
17. Re-record facility on stereo models for multi-play, echo effects etc., without external connections.
18. Meters switchable to read 100 kHz bias and erase supply with accessible preset adjustment.
19. Three outputs per channel i.e. (1) line out - level response. (2) line out - after tone controls. (3) power output - 8-15 ohms.
20. Power output 10W per channel.
21. Independent tone controls giving full lift and cut to both bass and treble each channel.
22. Retractable carrying handle permitting carrying by one or two persons.



Ideal for rack mounting



Grey vinyl case



Elegant hardwood case

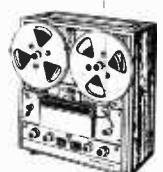

Listen for yourself

To *know* the Ferrograph New Generation Series 7 you must look at it, listen to it, for yourself. You will find New Generation instruments soon in stock at many of the best tape-recording and Hi-Fi specialists in the country, including the following:

Ferrograph stockists

London Dealers
Telesonic Ltd.,
92, Tottenham Court Road,
London, W.1

Larg's of Holborn Ltd.,
76/77, High Holborn,
London, W.C.1

Nusound,
82, High Holborn,
London, W.C.1

Nusound,
228 Bishopsgate,
London, E.C.2

Nusound,
360 Kilburn High Road,
London, N.W.6

Nusound,
36 Lewisham High Street,
London, S.E.13

Francis of Streatham,
169-171, Streatham High Road,
London, S.W.16

Hampstead High Fidelity Ltd.,
91 Heath Street,
London, N.W.3

The Recorder Company,
188, West End Lane,
London, N.W.6

C. C. Goodwin Ltd.,
7, The Broadway,
London, N.22

Nusound Recording Co. Ltd.,
191, Plashet Road,
Upton Park,
London, E.13

Studio Tapes Ltd.,
199, Hoe Street,
Walthamstow E.17

Aberdeen
Aberdeen Sound Centre,
25a, Belmont Street.

C. Bruce Miller,
51, George Street.

Aberdeen Radio Ltd.,
9 Hadden Street.

Barnsley
Geoffrey Barnard,
3, Pitt Street.

Barnstable
O. Nicklin & Son Ltd.,
The Square.

Bath
C. Milsom & Son Ltd.,
Northgate.

Birkenhead
James McKenzie Ltd.,
Grange Road.

Birmingham
C. H. (High-Fidelity) Ltd.,
167/169, Bromsgrove Street,
Birmingham, 5.

Chas H. Young Ltd.,
170, Corporation Street.

Griffin Radio Ltd.,
94, Bristol Street,
Birmingham, 5.

Blackburn
Holdings of Blackburn Ltd.,
39-41, Mincing Lane.

Blackpool
F. Benfell Ltd.,
17, Cheapside.

Bolton
Harker & Howarth (Music)
Ltd.,
Goodwin Street,
Bolton, Lancs.

Bournemouth
Tape Recorders (Bournemouth)
Ltd.,
874, Old Christchurch Road,
Boscombe, Bournemouth.

Brighton
John King Films Ltd.,
71, East Street.

Avery's Ltd.,
77, St. James's Street.

Lanes Radio Ltd.,
11, Gardiner Street.

Bristol
Tape Recorder and Hi-Fi
Centres Ltd.,
Stokes Croft.

Sound Selection Ltd.,
361-363, Gloucester Road,
Bristol 7.

Bromley
Bromley Sound,
22, Letchworth Drive.

Bury
John Smith & Son (The Rock)
Ltd.,
184, The Rock,
Bury, Lancs.

Cambridge
University Audio,
1-2, Peas Hill.

K.P. Cameras Ltd.,
12a, Kings Parade.

Canterbury
Canterbury Hi-Fi,
St. Dunstan Road.

Cardiff
Sound Film Services Ltd.,
(Cinema Liaison Ltd.),
27, Charles Street.

Carlisle
Misons,
Citadel Road.

Coventry
Coventry Tape Recorder
Services,
33, King William Street.

R.E.S. Ltd.,
13, City Arcade.

Crewe
J. H. Charlesworth (Crewe) Ltd.,
28, Hightown,
Crewe, Cheshire.

Darlington
Geoffrey A. Williams & Son
Ltd.,
Blackwell Gate.

Derby
Victor Buckland Ltd.,
41-49, London Road.

Doncaster
Tom Jaques Ltd.,
16, Wood Street,
Doncaster, Yorks.

Edinburgh
J. Nicholson (Hi-Fi Corner) Ltd.,
1, Haddington Place,
Edinburgh 7.

Epping
Chew and Osborne Ltd.,
148, High Street.

Exeter
Electrosure Ltd.,
162-163, Fore Street.

Farnham
Lloyd & Keyworth Ltd.,
26-27, Downing Street,
Farnham, Surrey.

Gerrards Cross
Edric Films Ltd.,
34-36, Oak End Way,
Gerrards Cross, Bucks.

Gillingham
E. Hadaway,
Watling Street.

Glasgow
McCormacks (Music) Ltd.,
33 Bath Street,
Glasgow, C.2.

Goodmayes
Unique Radio Ltd.,
6, The Facade,
Goodmayes, Essex.

Gravesend
Bennett & Brown Ltd.,
50, 60b & 60c, Wrotham Road,
Gravesend, Kent.

Great Yarmouth
Norfolk Radio,
12, Broad Row,
Gt. Yarmouth

Guilford
P. J. Equipments,
21, Onslow Street.

Huddersfield
J. Wood & Son Ltd.,
67, New Street,
Huddersfield, Yorks.

Ilford
Nusound,
87-100, Pioneer Market,
Ilford Lanc.,
Ilford, Essex.

Kirkcaldy
Caithness Brothers,
270, High Street.

Leamington Spa
W. M. Tysons,
41, Russell Street,
Leamington Spa, Warks.

Leeds
Beckett's Film Services Ltd.,
The Headrow,
Leeds 1, Yorks.

Leicester
United Film Services,
7, King Street.

Linton
H. S. W. Speechley & Co.,
49, High Street,
Linton, Cambs.

Liverpool
Beaver Radio (Liverpool) Ltd.,
60, Whitechapel,
Liverpool, Lancs.

Luton
Coventry Radio Ltd.,
189, Dunstable Road,
Luton, Beds.

Maidstone
Sloman & Pettit,
Pudding Lane.

Manchester
Lancs Hi-Fi Ltd.,
8, Deansgate,
Manchester, 3.

Godleys Radio & T.V. Ltd.,
Shude Hill.

Mansfield
Syd Booth,
11, Queens Street.

Middlesbrough
McKenna & Brown Ltd.,
122, Linthorpe Road,
Middlesbrough, Yorks.

Newcastle-upon-Tyne
Turners (Newcastle-upon-Tyne)
Ltd.,
Camera House, Pink Lane,
Newcastle-upon-Tyne.

J. G. Windows Ltd.,
1-7, Central Arcade.

Northampton
Audiocraft Ltd.,
Abington Square.

Nottingham
Petes Electronics Ltd.,
165, Arkwright Street.

Nuneaton
Taylors Pianos Ltd.,
119, Abbey Street

Oxford
L. Westwood Ltd.,
George Street.

Plymouth
A. E. Ford Ltd.,
84, Cornwall Street.

Portsmouth
H. R. Knight,
71, Tangier Road.

Redcar
McKenna & Brown Ltd.,
135, High Street,
Redcar, Yorks.

Rugby
Berwick Hi-Fi Centre,
5, Sheep's Street,
Rugby, Yorks.

Salisbury
Suttons Hi-Fi Centre Ltd.,
50, Blue Boar Row,
Salisbury, Wilts.

Skegness
Norman Throp Ltd.,
68, Lumley Road,
Skegness, Lincs.

Sheffield
Sheffield Photo Co. Ltd.,
6, Norfolk Row,
Furgate.

Shrewsbury
Avon Hi-Fi Ltd.,
13, Wyle Cop,
Shrewsbury, Salop

Southampton
Hamiltons Ltd.,
35, London Road.

Southport
Wayfarers Radio Ltd.,
Burton Arcade.

Stafford
Tom Reekie Ltd.,
10, Bridge Street.

St. Helens
Harold Stott Ltd.,
18, Westfield Street,
St. Helens, Lancs.

Stoke-on-Trent
Wilsons Radio Ltd.,
30-32, Liverpool Road,
Stoke-on-Trent, Staffs.

Stockport
W. J. & M. Bayliss Ltd.,
611, Gorton Road,
Reddish, Stockport.

Swansea
W. J. Holt Ltd.,
Picton Arcade.

Teddington
Daytronics Ltd.,
119a, High Street,
Teddington Lock, Middx.

Truro
John Fry Ltd.,
6, Cathedral Lane,
Truro, Cornwall.

Winchester
Southern Recorder Service,
34, St. Georges Street.

Woking
D. W. Hughes & Sons Ltd.,
5, Central Buildings
Chobham Road.

Worcester
Johnson's Sound Service,
Sidbury.

Wilmslow
Transistor Centre,
Green Lane,
Wilmslow, Cheshire.

Worthing
Bowers & Wilkins Ltd.,
1, Beckett Buildings,
Littlehampton, Worthing.

If none of these is near enough to you, in case of difficulty, or for free literature, send us the coupon, or give us a ring on WATERloo 1981.

FERROGRAPH

To The Ferrograph Co Ltd
Ferrograph House
84 Blackfriars Road London SE1
Please send me a free brochure on the
Ferrograph New Generation Series 7

NAME

ADDRESS

WW



WW—123 FOR FURTHER DETAILS

Recent Products

There follows a procession of brief technical reports, each report bringing together details of the more important features which contribute to the performance of a tape recorder. The selection of models for this survey has been made from data submitted by manufacturers, less than 50% of whom responded to our invitation. The choice is quite arbitrary as to manufacturer but specific when it comes to quality. Thus the reader will find that prices, when given, are often over £100. By comparing one recorder with another it is quite possible to determine where the money is going, and the reader should at least be able to decide from this survey the best combination of characteristics to suit his needs most economically.

Some models described are full tape recorders, having power amplifiers and built-in speakers. Others are decks, having low-level signal processing circuitry only. The third category included is the mechanical tape transport system, which requires fitting out, in the first place, with suitable tape heads.

To avoid unnecessary repetition we have omitted the unit abbreviation i.p.s. when quoting speeds and have also eliminated certain specifications from the manufacturer's data before writing the reports. The following information covers omissions—

- 1). Wow and flutter is not given for any speed unless it is above 0.15% r.m.s.
- 2). Noise is not mentioned if below 55dB, and channel cross-talk not mentioned if below 40dB.
- 3). Unless specifically stated otherwise, all models will work off the standard British 50Hz mains.
- 4). No reference is made to sockets and leads.

One point about frequency response. In some cases frequency response is given with appropriate power fall off at the extremes of the range. In other cases simply the range is given.

The Ferrograph Series Seven three-speed recorders suitable for horizontal and vertical use come in three versions—mono (with a 10W output), and two stereo versions, one with 10W per channel output and the other having low level output for external playback amplification. The frequency response is 30Hz-20kHz ± 2 dB at 15, 30Hz-17kHz ± 2 dB at $7\frac{1}{2}$, 40Hz-14kHz ± 3 dB at $3\frac{1}{2}$, and 50Hz-7kHz ± 3 dB at $1\frac{1}{8}$. Wow and flutter is less than 0.20% at $1\frac{1}{8}$. Speeds are accurate to $\pm 1\%$. The bias frequency is 100kHz. Input

sensitivities for full depth recording are 150 μ V-15mV at greater than 10k Ω for microphone (recommended source 250-2000 Ω), and 75mV-10V at 2M Ω for any impedance of line source. Outputs per channel are 600 Ω at 2.4V (unloaded), a low level of 300mV into 10k Ω or greater, and 10 watts r.m.s. into 8-16 Ω . The bass and treble controls are fully variable. A wide range of facilities are included: variable spooling allows for easy indexing and editing; electrical deck operation allows pre-setting for time-switch starting without requiring the machine to be previously powered; an instantaneous stop/start by electrical control; immediate access to the head block for editing; adjustable reel height control with $8\frac{1}{4}$ inch reel capacity; damped tension-arms for slur-free starting; two inputs per channel with independent mixing; re-record facility on stereo models for multi-play, echo effects etc. without external connections. Alternative presentations for the different versions are: uncased, natural wood case, and covered portable case. The Ferrograph Co. Ltd., 84 Blackfriars Road, London, S.E.1. WW 382 for further details.

Philips tape recorder model PRO'35 is a full track or half track 2 speed monophonic or stereophonic deck intended for horizontal operation. The unit comes in console (photo), portable, and unmounted versions. Frequency response at 15 is 40Hz-15kHz ± 1.5 dB, and at $7\frac{1}{2}$ is 40Hz-12kHz ± 1.5 dB. Speed difference between start and finish of tape is less than 0.2%. During

record or playback the full speed is reached 0.1 seconds after start up. The bias frequency is 94kHz, and bias current is adjustable. Solid state plug-in modules perform the various signal processing functions. The recording amplifiers have input impedances of 8-10k Ω for the frequency range 30Hz-15kHz with source impedances of 200 Ω or 600 Ω . The minimum input voltage for the rated output is 0.5V. An input microphone pre-amplifier can be included in the portable version. The output impedance of the playback



amplifier is 100 Ω at 1kHz, and the output voltage into 600 Ω or 200 Ω is +6dBm (1.55V), max. +20dBm (7.75V). The deck measures 29 x 22 $\frac{1}{2}$ x 35 $\frac{1}{2}$ inches and weighs 135lb approximately. The stereo recorder shown costs £1,040. Agents: Peto Scott Ltd., Addlestone Road, Weybridge, Surrey. WW 376 for further details

Dolby Laboratories' professional audio noise reduction system has been incorporated into a semi-professional tape recorder, and K.L.H. Research and Development Corporation of Cam-



bridge, Massachusetts, have been licensed to manufacture and sell the model in the U.S.A. and Canada. K.L.H. are also arranging production in other parts of the world. In this machine the noise reduction operates only at frequencies above 3kHz, where hiss is a problem; 10dB of hiss reduction is achieved. This means that when running at $3\frac{1}{2}$ the hiss level is less than that of a normal professional machine running at 15 i.p.s. Provision is made for disabling the noise reduction circuitry to allow the replay of tapes recorded normally. A $7\frac{1}{2}$ speed is provided to allow replay of other tapes as mentioned and also to facilitate editing of "Live" takes, but otherwise $3\frac{1}{2}$ is sufficient for serious musical recording. Dolby Laboratories, 590 Wandsworth Road, London, S.W.8. WW 383 for further details.

Revox A77 is a stereophonic 2 or 4 track two speed tape recorder for horizontal or vertical operation. The tape speeds are $3\frac{1}{2}$ and $7\frac{1}{2} \pm 0.2\%$. Frequency response via tape is from 30Hz-20kHz $\pm 2-3$ dB at $7\frac{1}{2}$. The bias oscillator frequency is 120kHz.



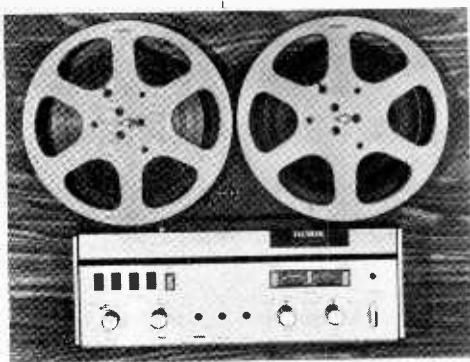

The deck has three motors, the capstan motor being electronically governed. Back tension from the feed-spool and constant tension from the take-up spool are provided by two smooth running high torque motors. Braking is assisted by an electromagnetic servo system. Recording technique facilities include sound on sound, multiplay, echo, on-off tape monitoring as well as playback to both European and American equalization standards. The use of relays and solenoids permits all tape transport function to be operated by remote control including going into the record mode. There are inputs on each channel for high and low impedance microphones, sensitive to 15mV and 2mV respectively, a radio input, 2mV into 33kΩ, and an auxiliary input sensitive to 40mV into 1MΩ. The portable model has two output amplifiers and four built-in speakers. Each amplifier can supply 8W to an 8Ω load at less than 1% distortion. The weight is approximately 34lb. When modified to take 10½ inch spool only, and provided supply is direct to scientific or industrial users only, the recorder will be exempt from purchase tax. Agents: C. E. Hammond & Co. Ltd., 9 High Street, Eton, Windsor, Berks.

WW 393 for further details

Brenell STB2 is a four speed, 2 track stereophonic tape deck intended for horizontal operation. Frequency response is from 40Hz—15kHz ± 2dB, 40Hz—14kHz ± 3dB at 7½, 40Hz—11kHz ± 3dB at 3¼ and 40Hz—6kHz ± 3dB at 1½. Wow and flutter is less than 0.25% at 1½. Separate record and replay heads are used, there being two replay heads one for replay of mono and stereo 2/4 tapes. Two models are available. The STB2/5/2 allows for a maximum spool size of 8¼ inches, but the STB2/510/2 can take a 10½ inch NAB spool. Four channel mixing is possible for mono recording and two channel mixing for stereo. The input channel may be independently adjusted to match microphones, radio tuners, gramophone pickups, pre-amps etc. Two illuminated edgewise scaled meters measure recording level, tape output level, and bias level. The variable bias allows for optimum results with different tape brands. Superimposing and monitoring facilities are built in. The recorder, which uses valves throughout, employs d.c. heat-



ing in the record and replay pre-amplifiers. The deck switches are interlocked to prevent rewind in the record mode. The input sensitivities for each channel can be adjusted from ½mV to 1V into 1MΩ. Compensation is included for ceramic and crystal pickups. Recording and replay characteristics are selected to suit the tape speed by a single control. Outputs of a few millivolts to 1.5V across 47kΩ are obtainable from a cathode follower. An optional extra is an internal mounting stereo amplifier with two monitoring loudspeakers. Price of the STB2/5/2 is £150 including 1200 feet of tape, a 7 inch spool, and 6 jack plugs. Model STB2/510/2 costs £170. Brenell Engineering Co. Ltd., 231-235 Liverpool Road, London, N.1.

WW 397 for further details

The Wyndors Vanguard is a 4-track three-speed monophonic tape recorder that can be used (with head amplification and equalization) for stereophonic replay. Deck facilities include fast forward and reverse rewind, a digital tape position indicator, an interlocking record/replay control, bass and treble controls, separate record and replay gain controls and an illuminated V.U. recording level meter. Frequency response is 40Hz—15kHz ± 3dB at 7½, 40Hz—9kHz ± 3dB at 3¼ and 40Hz—6kHz ± 4dB at 1½. Wow and flutter are 0.25% at 3¼, and 0.3% at 1½. The bias oscillator frequency is 66kHz. The three head system is exploited to allow, besides the double play facility



track to track (sound on sound) recording. There are separate record and replay amplifiers and either an incoming signal or a tape signal can be monitored. The replay amplifier may be used straight through, having a frequency response 20Hz—20kHz ± 2dB. There is an input for microphone with a sensitivity to 1mV across 500kΩ, and a radio/gram input with sensitivity to 60mV across 1MΩ. Besides a loudspeaker output of 4 watts into 15Ω, there is a ¼v output across 10kΩ. An 8-inch loudspeaker is fitted into the detachable lid. Accessories include 1,800ft. long play BASF tape and 2 spare jack plugs. A ribbon microphone can be supplied. The recorder measures 18 x 18 x 14in and weighs 40lb. Price 72 guineas inc. p.t. Wyndors Recording Co. Ltd., Wyndors Works, Bellevue Road, Friern Barnet, London, N.11.

WW 392 for further details

Vortexion recorder type CBL/7T uses the series 7 solenoid controlled deck. Two f.e.t.s are used on each playback channel and one in each microphone and auxiliary channel. Gain stabilization and low intermodulation distortion are achieved by feedback loops used over every stage. Two stereo and two mono models are available. Each model has three speeds, either 3¼, 7½ and 15, or 1½, 3¼ and

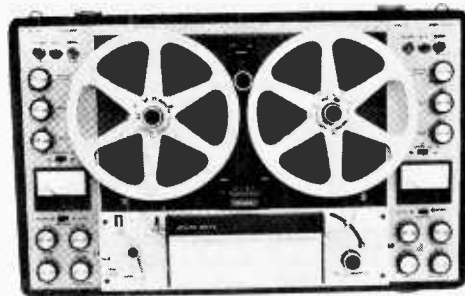

7½. The frequency response ± 2dB is from 30Hz—18kHz at 7½. Output power is 10 to 15W. Monitoring facilities are included. Above the dual scaled peak programme meter for signal and adjustable bias levels, there is a cross mix switch for sending the signal from one channel to the other. Clearances are such that 8¼ in. spools may be accommodated even in the closed position. The price of the lower speed stereo model is £189. Vortexion Ltd., 257-263 The Broadway, Wimbledon, London, S.W.19.

WW 387 for further details.

The Crown SX 800 is a two speed stereophonic tape deck with a guaranteed minimum frequency range of 30Hz to 20kHz ± 2dB at 7½ and 30Hz—10kHz ± 2dB at 3¼ using Scotch 202 type tape or equivalent. The signal-to-noise ratio is 50dB at 3¼. The V.U. meters (five inches wide) are edge-illuminated. The bias frequency is 100kHz. Record interlock guards against accidental erasure. Separate record and playback amplifiers provide isolation for monitoring while recording. Distortion throughout all audio circuits approaches the threshold of measureability. A photocell automatic stop halts operation in case of tape breakage or end-of-tape. This can be used to sense windows in the tape for special cueing functions. A reel size switch provides proper tension for either 10½ inch or 7 inch reels. Four lighted push buttons (FORWARD, REWIND, STOP and OPERATE) control and indicate operation. These functions may be remotely controlled. The stop time is 3 seconds from full rewind speed on 10½ inch reels. Braking is electro-magnetic and never needs adjusting. During fast spooling the tape is away from the heads. 1200 feet can be wound in 38 seconds, and 2400 feet on a 10½ inch reel in 58 seconds. Inputs are for 4 microphones or 4 lines (2-input mixer per channel). Microphone sensitivity is -66dBm (0.4mV) min. for 'O' level. Line sensitivity is -25dBm (45mV) min. for 'O' level. All input impedances are 100kΩ or above. Two outputs are provided for each channel. Both are 600Ω unbalanced with output up to 2.5V for 'O' level. Maximum undistorted output is 14V. A switch for each channel allows monitoring from either the source (the meter reading the incoming signal to the record head) or from the tape (the meter reading the 'calibrated playback level). In its case the deck weighs 48lb and measures 15¼ x 19 x 8 inches. Accessories available include a stereophonic power amplifier, a balanced 600Ω output trans-



former, and a 50-250 Ω microphone input transformer. Price £634 plus duty. Agents: Carston Electronics Ltd., Electra House, Wigganhall Road, Watford, Herts.

WW 380 for further details.

EMI tape recorder type L4 is a 2-speed, half- or full-track portable. Separate record and replay channels allow for continuous monitoring of the recorded signal. The two speeds 7 $\frac{1}{2}$ and 3 $\frac{3}{4}$, are stable to better than 0.5% with a constant 14V supply from the internal battery or mains power



unit. Wow and flutter is better than 0.2% at 7 $\frac{1}{2}$ and 0.3% at 3 $\frac{3}{4}$ when playback is on the machine that made the recording. The overall frequency response at 7 $\frac{1}{2}$ i.p.s. is 50Hz to 12kHz \pm 2dB. Maximum spool size is 4 $\frac{1}{4}$ inches. Separate erase, record and replay heads are fitted, and provision is made for mounting a fourth head for use in sound synchronizing systems. Two inputs, with separate mixing controls, are provided for low impedance (30 to 50 Ω) microphones, and a third input will accept a floating or unbalanced signal source of up to 10k Ω impedance. Line-out is set to 0dBm into a 600 Ω line, but a pre-set gain control can be adjusted to give an output of up to +6dBm. An edge-mounted meter can be switched to monitor battery voltage, erase and bias oscillator current, recording level, and line-out. The signal can also be monitored before and after recording by an internal loudspeaker or by headphones. The sealed lead-acid accumulator will give up to three hours continuous recording. Weight 10 $\frac{3}{4}$ lb with battery. A mains unit is available. Price of half track machine £120. EMI Electronics Ltd., Hayes, Middx.

WW 389 for further details

The National model RS7615 is a transistorized 4 track stereophonic tape recorder for vertical or horizontal operation. The tape speeds are 7 $\frac{1}{2}$,

3 $\frac{3}{4}$, and 1 $\frac{7}{8}$. Wow and flutter at 3 $\frac{3}{4}$ is below 0.20%, and below 0.25% at 1 $\frac{7}{8}$. The limits of the frequency response are given as 30Hz to 18kHz at 7 $\frac{1}{2}$, 30Hz to 13kHz at 3 $\frac{3}{4}$ and 30 to 6kHz at 1 $\frac{7}{8}$. The bias frequency is 50kHz. The maximum spool size is 7 inches. Input figures are given as 5.6k Ω -74dB for the two microphones and 100k Ω -20dB for AUX inputs. There are two line outputs at 10k Ω -2dB, two 8 Ω extension speaker outputs, and the 8 Ω headphone output. The recorder is equipped with its own speakers—a "tweeter" and "woofer" for each channel—and the power amplifier section delivers 8W to each channel. Recording level is indicated on two V.U. meters, and there is a 4 digit push-reset tape counter. The spooling time for "fast forward" is about 3 $\frac{1}{2}$ minutes for 1200 ft of tape and rewind time a little faster.

Separate treble and bass controls are provided and there are monitoring and sound-with-sound recording facilities. The weight is 22lb and the approximate dimensions of the walnut case 17 $\frac{1}{4}$ x 11 $\frac{1}{4}$ x 6 $\frac{1}{2}$ inches. Price £162 15s. incl. p.t. Agents: Unamec Ltd., P.O. Box 1, United Africa House, Blackfriars Road, London, S.E.1.

WW 395 for further details

Ferguson Model 3232 tape recorder is a three-speed stereo recorder intended for horizontal operation. The frequency ranges are 40Hz to 18kHz at 7 $\frac{1}{2}$, 40Hz—14kHz at 3 $\frac{3}{4}$, and 40Hz—7kHz at 1 $\frac{7}{8}$. Wow and flutter are given as less than 0.2% at 3 $\frac{3}{4}$ and less than 0.25% at 1 $\frac{7}{8}$. The signal to noise ratio is 45dB unweighted. There is a single tone control. The record level indication is by two calibrated meters. Tape position is indicated by a four digit push-button reset counter. The output



power is 5W per channel and there are two speakers, 5 x 5 inches, built into the cabinet for monitoring. The maximum reel size is 7 inches. Housed in a walnut or teak veneered cabinet the fully transistorized unit is in effect two recorders and reply amplifiers independently controllable. The record buttons are interlocked to prevent accidental erasure. The tape movement controls are keys. The microphone and radio input requirement

is 250 μ V into 4.7k Ω . Provision is also made for inputs of 50mV into 1M Ω (pickup) and 100mV into 100k Ω . There is an output of 500mV across 10k Ω . The recorder is supplied with 1,200ft. of long play tape, an empty spool, 2 dynamic microphones with stands, a hand operated remote control switch and a recording lead. The dimensions of the recorder are 16 $\frac{7}{16}$ x 14 $\frac{3}{32}$ x 7 $\frac{1}{2}$ in. Price £91 13s. British Radio Corporation, Ltd., 284 Southbury Road, Enfield, Middx.

WW 390 for further details

The TRD 1 tape decks come in two types—the solenoid operated version which is available for remote control (TRD1/5) and the mechanical version with variable speed rewind (TRD1/VR). Both



of these are available with high speeds (1 $\frac{7}{8}$, 3 $\frac{3}{4}$, 7 $\frac{1}{2}$ and 15) or lower speeds (1 $\frac{5}{8}$, 1 $\frac{3}{8}$, 3 $\frac{3}{4}$ and 7 $\frac{1}{2}$). Two switches on the mechanical type, and four push buttons on the solenoid type provide the simple controls, all of which are mechanically interlocked to prevent misuse. A record lock prevents accidental erasure and this control is connected to a wafer switch for control of the recording circuitry. All operations on the TRD1/5 are controlled by latching solenoids. Tape transport is by a Paps hysteresis synchronous motor. Wow and flutter is less than 0.2% at 1 $\frac{7}{8}$ and less than 0.35% at 1 $\frac{5}{8}$. Up to four Bogen heads can be fitted. The top plate measures 17 x 11 $\frac{1}{4}$ inches. The weight is 26lb. Price £80.7.0 Tape Recorder Developments Ltd., 6 Fulbrook Mews, Tufnell Park, London, N.19.

WW 384 for further details

The Uher Royal de luxe two or four-track stereo tape recorder uses a single Papst hysteresis synchronous external motor and is fully transistorized. Four tape speeds are possible—7 $\frac{1}{2}$, 3 $\frac{3}{4}$, 1 $\frac{7}{8}$ and 1 $\frac{5}{8}$. The frequency range is given as 20Hz—20kHz at 7 $\frac{1}{2}$, 20Hz—15kHz at 3 $\frac{3}{4}$, 20Hz—9kHz at 1 $\frac{7}{8}$ and 20Hz—5kHz at 1 $\frac{5}{8}$. Wow and flutter is \pm 0.25% at 1 $\frac{7}{8}$. The bias oscillator frequency is 100kHz. Operation is possible in any position—horizontal, vertical and in between. This is due to the use of a tape tension comparator, which maintains constant tape tension under all conditions. The capstan and pressure roller determine the speed of the tape but do not transport it. The speed is steady to 0.1%. Inputs are for microphone (200 Ω , 0.2mV to 100mV), radio (47k Ω , 2mV to 1V), phono 1 (1M Ω , 50mV to 10V) and phono 2 (50k Ω , 200mV to 10V). Outputs are $\frac{1}{2}$ volt across 15k Ω , a monitor (also $\frac{1}{2}$ volt across 15k Ω) and power output of 10 watts per channel—6.4V across 4 Ω . Vernier adjustment of the playback head allows for alignment to match recordings made on different machines. The head mounts are fully interchangeable, and this recorder can very simply be changed from four track operation to two track, and vice versa. Echo and reverberation facilities are incorporated and a built in 'Dia-Pilot' pulser can be used to synchronize playback with an automatic slide projector. Also, up to six recordings can be made in succession. A single switch turns the tape recorder into a stereophonic amplifier. Accessories, to be bought separately, include microphones, earphones, and connecting leads. The weight of this instrument

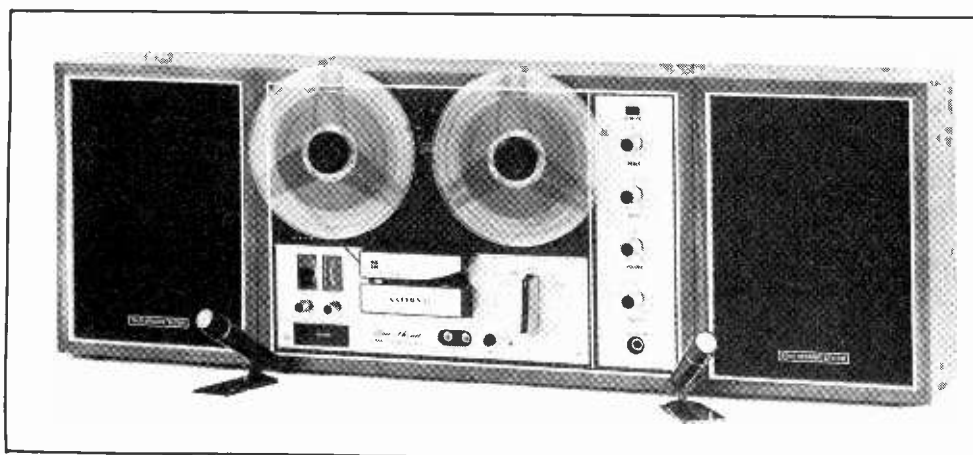



EAGLE ANNOUNCE AN IMPORTANT NEW TAPE DECK

MODEL TC.450H. This is a newly developed 4-track **Stereo Tape Deck** fitted with completely transistorized record and play-back pre-amplifiers and oscillator circuitry. This outstanding engineering development includes among the many important features a low noise Hysteresis Synchronous motor and long life micro-gap fully shielded magnetic heads. All record and replay inputs and outputs are fitted with both phono and DIN sockets and a kit of phono-DIN connector cord assemblies is supplied with the unit. The output is continuously variable up to a maximum of 1 Volt. Maximum reel diameter 7". Speeds $3\frac{3}{4}$ " and $7\frac{1}{2}$ " ips at very low wow and flutter content. Operates in both vertical and horizontal mode and supplied as standard in a handsome Teak plinth.



Distributed by
B. Adler & Sons (Radio) Ltd.
Audio Division
Coptic Street, London, W.C. 1

EAGLE VERSATILITY AND RELIABILITY FOR £69. 10. 0 INC. P.T.

WW—126 FOR FURTHER DETAILS



is approximately 29½lb. Price £242 11s. inc. p.t. Agents: Bosch Ltd., 205 Great Portland Street, London, W.1.

WW 391 for further details

40Hz-15kHz at 3¼. Wow and flutter at 7½ is 0.2%, and at 3¼ is 0.25%. Pre- and post-record monitoring is possible, and the separate record and replay heads allow echo and reverberation effects to be recorded. There are inputs for microphone and radio or pickup, and outputs for headphones and external amplifier. The deck measures 18¼×12¼×4¼ inches and weighs 26lb. Agents: AEG (Great Britain) Ltd., Lonsdale Chambers, 27 Chancery Lane, London, W.C.2. WW 386 for further details.

Leavers-Rich Series E recorders. Four mounting types (one being portable), of single, dual and four channel recorders. Tape speeds are 15 and 7½ standard. Speeds 7½ and 3¼, and also 30 and 15, to order. Maximum spool size is 11½ inches (European) and 10½ inches (N.A.B.). Frequency response, within ±2dB, is between 35Hz and 18kHz at 15, and between 40Hz and 14kHz at 7½. The input is -10dBm for peak recording level. Input impedance is 600Ω and 16k ohms, balanced or unbalanced; also 250mV into 500kΩ unbalanced. The output impedance is 80Ω and the signal +20dBm into 600Ω from the peak level. The indicator is a V.U. meter, but a p.p.m. can be ordered. The portable model (2 tracks) measures 20×16×12 inches and weighs 75lb without the amplifier.

Two-speed capstan drive uses a hysteresis synchronous motor and coaxial stabilizer. Speed and direction of spooling are controlled by one knob, and the tape clears the head completely during spooling. Full remote control and signalling is possible, and speed and equalization is changed on one switch. There is a bias and erase meter for permanent indication, and individual bias adjustment and equalization for each speed. Accidental erasure is prevented by record interlock. An accurate timing indicator is driven by the tape. Illuminated push button controls oper-



ate self-latching relay systems. The open front head unit allows for tape marking. Access to all parts for routine maintenance is easy. Plug-in amplifier modules are used.

Price for the portable model dual channel recorder is £760. Leavers-Rich Equipment Ltd., 319 Trinity Road, London, S.W.18.

WW 379 for further details

The Telefunken M250 hifi is a 2 speed, two track stereophonic tape deck for horizontal operation. Frequency response is 40Hz-18kHz at 7½ and



Grundig T.S. 340 de luxe is a three-speed four-track stereo tape recorder. The frequency response is given as 40Hz-9kHz at 1½, 100-15kHz at 3¼ and 40-18kHz at 7½. Wow and flutter are less than 0.2% at 1½. The circuits incorporate both valves and transistors. Recording level is indicated on two illuminated V.U. meters and tape position by a four figure digital press button re-set counter. The maximum spool size is 7 inches. Inputs include two for microphones at 2mV into 1.5MΩ and two for radio and/or pickup at 100mV into 1MΩ. Two outputs at high impedance (600mV into 15kΩ) are provided besides points for two 8W 5Ω extension loudspeakers. Two 6 x 4 inch high quality elliptical speakers are



TRD 600 series

**INDUSTRIAL QUALITY
OUTSTANDING VERSATILITY
ALL DAY RELIABILITY**

THE ALL NEW 600 SERIES OF MACHINES BY TRD PROVIDES RECORDING QUALITY TO THE HIGHEST INDUSTRIAL STANDARD AT RELATIVELY LOW COST.

4 speeds. Pause control. Vari-speed spooling. Solid state, all silicon electronics. 600 ohm bridging impedance. 4 digit footage counter. 60 dB S/N ratio at 7½ i.p.s. Remote control facilities. BBC-type PPM. Switchable equalisation.

No other recorder of comparable price combines all these features. Studios and other serious amateurs are invited to write for descriptive literature to:

Tape Recorder Developments Ltd.

7 King George Avenue, Bushey, Herts.

Export inquiries to:

EXPOTUS LIMITED 10 Museum Street, London, W.C.1.
Tel: 01-836 3747

WW-127 FOR FURTHER DETAILS



Truvox PD 202/204 Tape Units are three speed, 2 or 4 track stereophonic record/playback decks for horizontal or vertical operation. Frequency response at $7\frac{1}{2}$ is 30Hz to 18kHz ± 2 dB, 30Hz—12kHz ± 2 dB at $3\frac{3}{4}$, and 40Hz—7kHz ± 3 dB at $1\frac{1}{8}$. Wow and flutter at $1\frac{1}{8}$ is better than 0.25%. The bias oscillator frequency is 90kHz. Full facilities are provided for off-the-tape monitoring, duo-play, track to track transfer and inching of the tape. Each channel has its own V.U. meter, record amplifier and playback amplifier with separate controls for each channel. Special circuitry automatically matches with other equipment. Microphone inputs are sensitive to 1mV at 50k Ω . Radio/pickup inputs are sensitive to 50mV at 200k Ω . Emitter follower outputs are variable with 1 volt maximum. Measuring 16 x 16 $\frac{1}{2}$ x 8 inches and weighing 28lb the units (both half and quarter track models) are supplied with interconnecting leads and cost £147 17s. 4d. including p.t. Truvox Ltd., Hythe, Southampton. **WW 399 for further details**

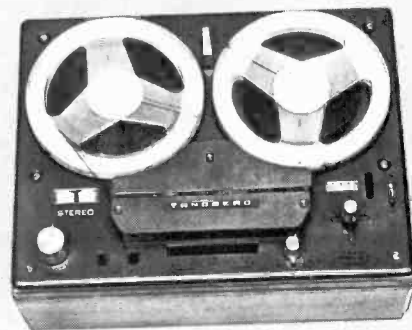

Tandberg series 6X Stereo is a 2 or 4 track 3 speed model using valves and transistors. Frequency response is from 40Hz-18kHz ± 2 dB at $7\frac{1}{2}$, 40Hz-14kHz ± 2 dB at $3\frac{3}{4}$, and 40Hz-8kHz at $1\frac{1}{8}$. Wow and flutter at $1\frac{1}{8}$ is better than 0.3%. Separate heads are used for erase, record and playback. There is an additional bias head. Separate record and playback heads permit monitoring off the tape a fraction of a second after recording, and also sound-on-sound recordings. A centre channel enables both tracks to be played back into mono headphones when the recorder is used for language teaching etc. There are individual mixer recording controls, separate playback controls for each channel, a four digit illuminated revolution counter, pause button, and optional remote control. F.M. multiplex filters are fitted. Microphone sensitivity is 1.5mV into 5m Ω . A high level (50mV into 1M Ω) and a low level (4mV into 100k Ω) input are provided as well as a low level radio input. A cathode follower output supplies 1.5V across 2k Ω , and there is an output of 150mV across 10k Ω for tape copying. The model

part of the recorder. Parallel track operation is possible and so is synchronous and multi-synchronous recording. A tape joining channel is provided. The tape can be inched and echo effect recorded. The system can be used for straight through amplification. Accessories supplied include 1,800 feet of LP tape on 7 inch spool and a spare spool. The recorder measures 21 x 16 x 8 $\frac{1}{4}$ inches, and weighs approximately 37lb. Price 179 guineas. Grundig (Great Britain) Ltd., London S.E.26. **WW 388 for further details**

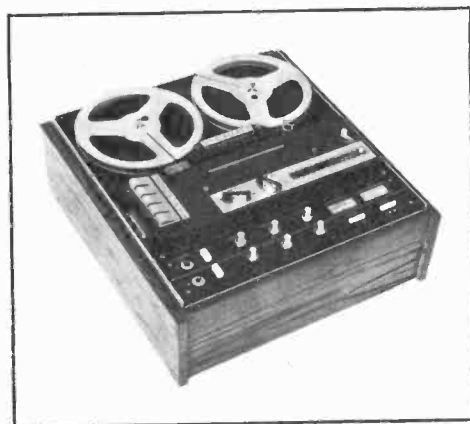

The Nagra IV series tape recorders are battery operated monophonic units operating in any position. Frequency response is 30Hz-20kHz ± 2 dB at 15, 30Hz-13kHz ± 2 dB at $7\frac{1}{2}$ and 30Hz-7kHz ± 3 dB at $3\frac{3}{4}$. The tape deck is mounted on the case with a three point suspension system. The capstan motor is servo stabilized. The whole unit has been constructed to military and aeronautical standards. More details will be available when the recorders are released in the Autumn. The price will be approximately £600. Agents: Hayden Laboratories Ltd., East House, Chiltern Avenue, Amersham, Bucks. **WW 375 for further details**



photograph by courtesy of
The Decca Record Company Limited

Professional Tape Recorders by **STUDER**

sole U.K. Agents:-

F.W.O. BAUCH LIMITED, Holbrook House, Cockfosters, Herts.

tel. 01-440 3277

WW-130 FOR FURTHER DETAILS

xvii

in its cabinet measures $15\frac{3}{8} \times 7\frac{1}{8} \times 11\frac{5}{8}$ inches and weighs 23lb. Price 138 guineas including p.t. Agents: Elstone Electronics Ltd., Hereford House, North Court, Leeds 2, Yorks. WW 385 for further details

The Chilton 100S is a stereo, three-speed, 2 or 4 track transistorized tape recorder intended for horizontal operation. The frequency response is 40Hz-15kHz ± 2 dB at $7\frac{1}{2}$, 50Hz-7.5kHz ± 2 dB at $3\frac{3}{4}$, and 50Hz-5kHz ± 3 dB at $1\frac{3}{4}$. Tone controls give ± 10 dB at both 50Hz and 10kHz. A single Papst hysteresis synchronous motor is used, and wind time for both directions is 100 seconds for 1200 feet. The oscillator frequency is 100kHz making the recorder suitable for f.m. multiplex inputs. The microphone inputs have a sensitivity of 0.8mV at 50k Ω , the radio inputs—80mV at 100k Ω . Two line outputs of 1V at 600 Ω are available besides two power amplifier outputs of 10W into 8 Ω . Chassis dimensions are $6\frac{1}{2} \times 13\frac{5}{8} \times 14\frac{1}{2}$ inches, and the weight is 32lb. Magnetic Tapes Ltd., Chilton Works, Garden Road, Richmond, Surrey.

WW 378 for further details

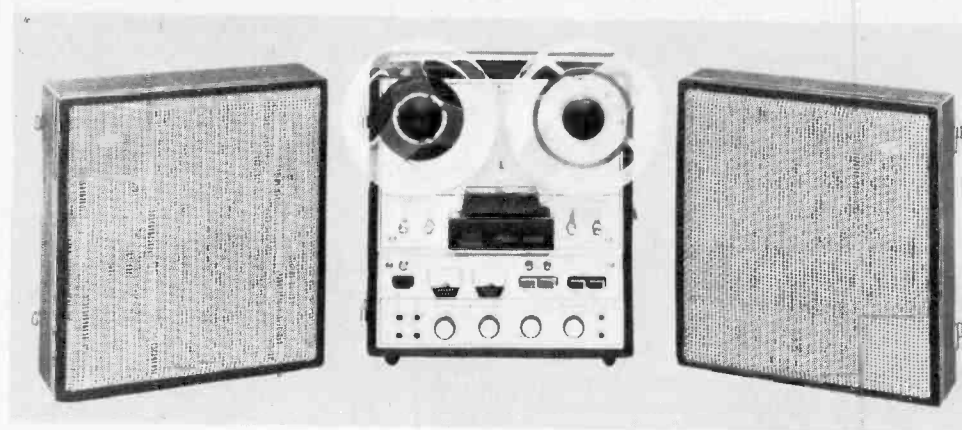
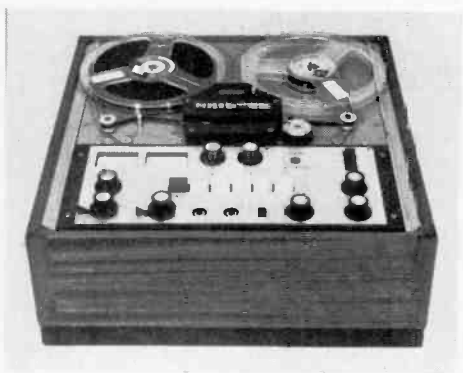

The OKI 555 transistorized 2-speed, 4-track stereophonic tape recorder is intended for both vertical and horizontal operation. Frequency response is from 40Hz—15kHz ± 2 dB at $7\frac{1}{2}$, and 50—10k ± 3 dB at $3\frac{3}{4}$. The bias frequency is 95kHz. Microphone inputs have an impedance of 10k Ω and a sensitivity of -70dB. The auxiliary inputs are of 500k Ω impedance and have -20dB sensitivity. Three watts per channel (undistorted) can be fed to the $6\frac{1}{2} \times 2$ inch speakers. There are facilities for sound on sound and f.m. multiplex stereo recording, and sound monitoring. The recorder, with speakers, measures $11\frac{3}{4} \times 13\frac{3}{4} \times 12\frac{1}{2}$ inches and weighs 24 $\frac{1}{2}$ lb. Price 129 guineas. Agents: Denham & Morley (Overseas) Ltd., Denmore House, 173/5 Cleveland Street, London, W.1. WW 398 for further details

—18kHz at $7\frac{1}{2}$. (50Hz—15kHz ± 3 dB) and 40Hz—14kHz at $3\frac{3}{4}$. Equalization is corrected for the playback of tapes recorded to the NARTB curve. A single 2-speed induction motor is used, and rewind and fast-forward time is 150 seconds for 1200 ft of tape. A push-to-reset digital tape posi-



The Akai 1710W Mignon stereo tape-recorder is a three-speed 4-track model for vertical or horizontal operation. Frequency response is 40Hz

THE DOLBY A301 AUDIO NOISE REDUCTION SYSTEM

Making the
Master
Recordings
of the
Future

NOISE REDUCTION SYSTEM A301
LABORATORIES LONDON

DOLBY LABORATORIES INC.

Already in use in eighteen countries, the Dolby system is making master recordings which will withstand the test of time.

The system provides a full 10 dB reduction of print-through and a 10-15 dB reduction of hiss. These improvements, of breakthrough magnitude, are valid at any time—even after years of tape storage. This is why record companies with an eye to the future are now adopting this new revolutionary recording technique.

A301 features: Easy, plug-in installation · solid state circuitry · modular, printed circuit construction · high reliability, hands-off operation. Performance parameters such as distortion, frequency response, transient response, and noise level meet highest quality professional standards. Price £700.

NEW optional half-speed adaptor modules for premium quality tape to disc transfers.

NEW Remote Changeover option cuts costs, enables one A301 unit to do the work of two.

We are exhibiting at the International Broadcasting Convention—September 9th-13th.

590 Wandsworth Road, London, S.W.8.
Tel: 01-622 0949/0897. Cables: Dolbylabs, London.

WW—131 FOR FURTHER DETAILS



Tandberg Model 11-2

The Battery Tape Recorder for the Sound Engineer

The new Model 11/2 incorporating these features:

- ★ Taco—Drive Motor System
- ★ 3 speeds— $1\frac{1}{8}$, $3\frac{3}{4}$ and $7\frac{1}{2}$ i.p.s.
- ★ Accepts 7" reels
- ★ Signal to noise ratio better than 58 db unweighted
- ★ Built-in electronic mixer for microphone and line inputs
- ★ Operates from dry batteries or optional mains unit
- ★ 3 Head system for on and off tape-monitoring.
- ★ A new-pilot tone version is also available for the professional film maker
- ★ Recommended Retail Price 171 gns.
- ★ A carrying case is also available as an optional extra

Specification

- ☆ Battery operated 10-16 volts
- ☆ 41 transistors, 10 diodes
- ☆ Speeds $1\frac{1}{8}$, $3\frac{3}{4}$ and $7\frac{1}{2}$ i.p.s.
- ☆ Speed tolerance better than 1%
- ☆ Frequency response, 40-16000 at $7\frac{1}{2}$ i.p.s. ± 2 db
- 50-9000 at $3\frac{3}{4}$ i.p.s. ± 2 db
- 60-4500 at $1\frac{1}{8}$ i.p.s. ± 2 db

- ☆ Wow and flutter better than .1, .15, .35 at $7\frac{1}{2}$, $3\frac{3}{4}$ and $1\frac{1}{8}$ i.p.s. respectively
- ☆ Input impedance—mike 200 at .1 mv balanced
- ☆ Low level—10 k at 5 mv
- ☆ High level—200 k at 100 mv
- ☆ Output line balanced 600
- ☆ Headphones 200
- ☆ Power output $\frac{1}{2}$ watt 2.7 v over 20
- ☆ Dimensions—length 13", height 4", depth 10", weight 9.5 lbs. excluding batteries.

For full details, please contact your local Tandberg dealer

**Industrial Department,
Elstone Electronics Ltd., Hereford House, North Court,
Off Vicar Lane, Leeds 2.**

Telephone: Leeds 39834.

move up to

Tandberg

tion counter is employed, and there is a V.U. meter for each channel. Both valves and semiconductors are used. A 4W power amplifier supplies two 5 x 7 inch speakers, but an optional matching stereophonic speaker system, SW50, is available. The size of the recorder is $14\frac{1}{8} \times 13\frac{1}{2} \times 7\frac{1}{2}$ inches and the weight 33lb. price £109 17s. 3d. incl. p.t. Agents: Pullin Photographic Ltd., 11 Aintree Road, Perivale, Greenford, Middx.

WW 396 for further details

TEAC model A-4010S stereo tape deck is intended for vertical operation. There are four, four-track 2 channel heads—record, forward playback, reverse playback and erase. The two tape speeds, $7\frac{1}{2}$ and $3\frac{3}{4}$ i.p.s. are accurate to $\pm 0.5\%$. The frequency response at $7\frac{1}{2}$ is 45Hz to 15kHz, and at $3\frac{3}{4}$ 50Hz-7.5kHz both ± 2 dB. Equalization is 50μ s for $3\frac{3}{4}$. Three motors are used—one hysteresis synchronous motor for capstan drive, and two eddy current outer-rotor motors for reel drive. The amplifiers are fully

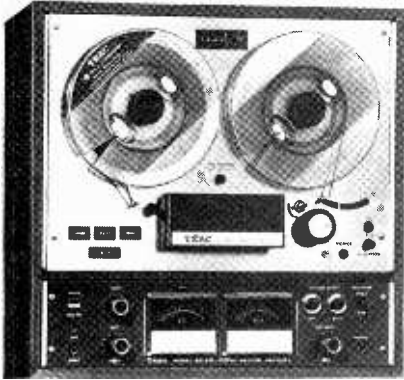

transistorized. Bias frequency is 100kHz. The microphone input required is 0.25mV minimum into $10k\Omega$, and the line input 0.14V minimum into $100k\Omega$. Output is 1V for a load of $100k\Omega$ or more. Two V.U. meters allow for correct independent level controls of both channels. Tape position is given by a 4 digit push-to-reset index counter. The deck has a stainless panel and is set in a wooden cabinet. Dimensions are $17\frac{1}{4} \times 17\frac{1}{2} \times 9\frac{3}{4}$ inches. The weight is 48lb. Agents: B. H. Morris & Co. (Radio) Ltd., 84-88 Nelson Street, London, E.1.

WW 377 for further details

The Scopetronics 1150 tape transport mechanism will operate in any position between horizontal and vertical. There are two controls—a 7-way function switch for record and playback, and a variable spooling knob. Three motors are used, with direct drive in the capstan from an external rotor high hysteresis motor. The speeds are 15 and $7\frac{1}{2}$. The brakes are mechanical wrap-round Ferodo linings, self-aligning and adjusting fail safe. Spool sizes can be cine 7-inch and $8\frac{1}{4}$ -inch, NAB $10\frac{1}{2}$ -inch or European $11\frac{1}{2}$ -inch—adaptors are provided. Three Scopetronic heads are fitted for erase, record, and playback in $\frac{1}{4}$ track, $\frac{1}{2}$ track (stereo), or full-track according to choice. The head assembly can be easily removed without upsetting the azimuth so changeover from full track to $\frac{1}{2}$ track etc., is possible. The back tension on the tape is automatically adjusted for different spool sizes by the speed change and spool size control. A cue device brings the tape in contact with the playback head when spooling, allowing exact location of a signal. For track selection two press buttons are provided. These buttons energize the oscillator and cannot be pressed unless the function switch is positioned for record or record standby. The rewind time for a 2400 foot NAB spool is 1 minute 45 seconds. The deck size

is $19 \times 17\frac{1}{2}$ inches (and suitable for standard rack mounting) and weighs 26lb. Price £154 10s. Scopetronics Ltd., Crown Works, Church Road, Kingston Upon Thames.

WW 381 for further details.

The Eagle TC450H is an all-transistor two-speed 4 track stereophonic tape deck. Frequency response is given as 30Hz - 17kHz ± 3 dB at $7\frac{1}{2}$, and 30Hz - 12kHz ± 3 dB at $3\frac{3}{4}$. Wow and flutter is less than 0.19% at $7\frac{1}{2}$, and less than 0.25% at $3\frac{3}{4}$. The bias frequency is 72kHz. A single hysteresis synchronous 4-pole motor is used. Input sensitivity is 300μ V at $50k\Omega$ for the microphone input and 60mV at $1M\Omega$ for the radio/pickup inputs. Output is 1 volt at 300Ω maximum, and this can be adjusted. Recording and playback equalization is to C.C.I.R. standards. V.U. meters are used for level indication. The maximum reel size is 7 inches. The deck measures $15 \times 13 \times 6\frac{1}{2}$ inches. Agents: B. Adler & Sons (Radio) Ltd., 32a Coptic Street, London, W.C.1.

WW 394 for further details



Decca Educational Service Tape recorders for education



3 Speeds— $7\frac{1}{2}$, $3\frac{3}{4}$, $1\frac{7}{8}$ —Two Track (VR2/E)—5 watts output—Vertical operation—8" round speaker faces class—Fully transistorized—Light Weight (21 lbs.).

designed and manufactured by **Van Der Molen Ltd**, 42 Mawney Road, Romford, Essex.

prices and further details from **Decca Educational Service**, 115 Fulham Road, London, SW3

WW—120 FOR FURTHER DETAILS

ADCOLA

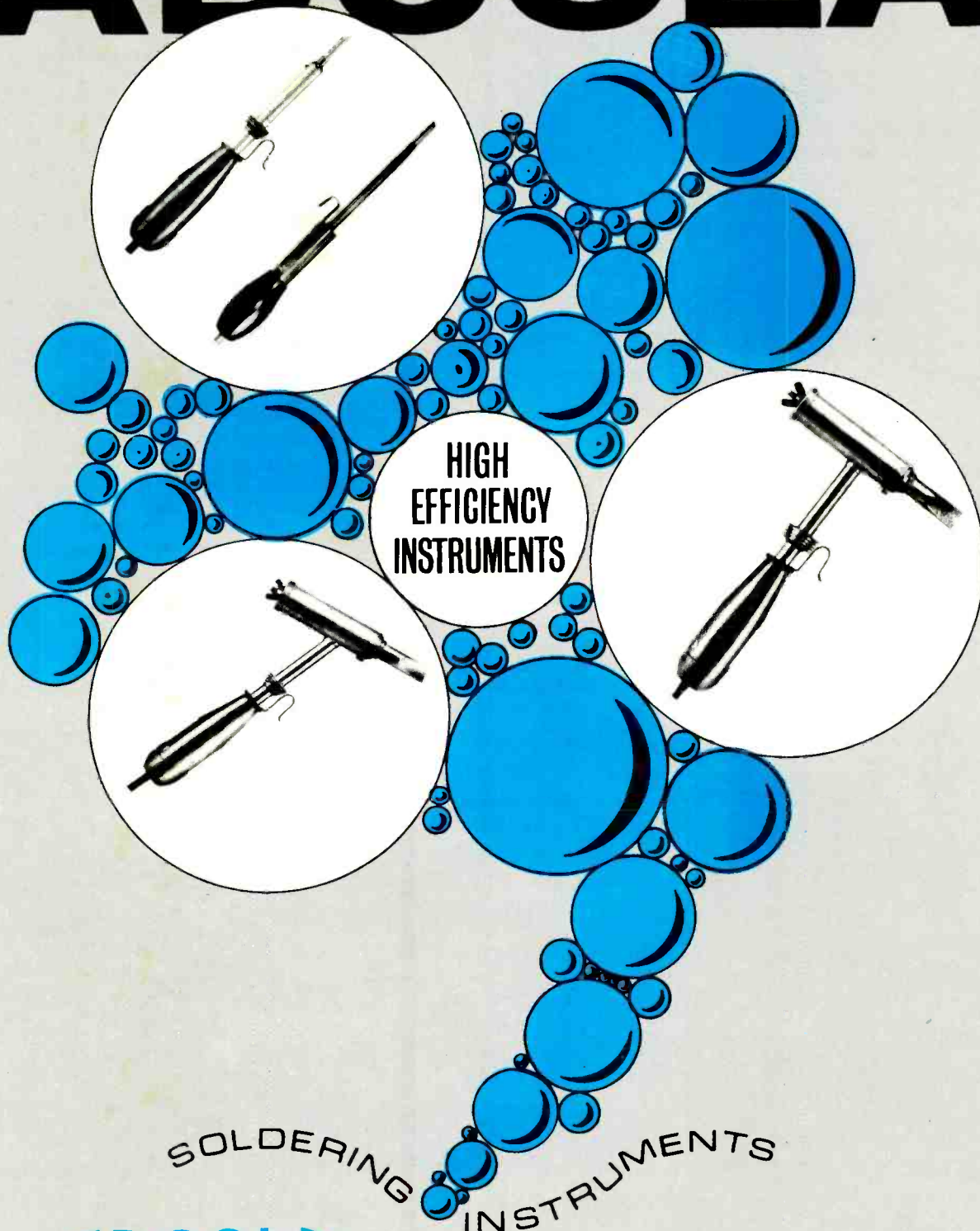

HIGH
EFFICIENCY
INSTRUMENTS

SOLDERING
INSTRUMENTS

ADCOLA
PRODUCTS LIMITED
(Regd. Trade Mark)

ADCOLA HOUSE
GAUDEN ROAD, LONDON S.W.4

AGENCIES IN ALL LEADING COUNTRIES

Telephone : 01-622 0291/3
Telegraphic Address : SOLJOINT, LONDON S.W.4

Bib

AUDIO & ELECTRONIC AIDS

-handy accessories that make all the difference



Wire Stripper & Cutter Model 3

Strips insulation without nicking the wire. Cuts wires and cables cleanly. Semi-permanently adjusted. Price 4/6d.



Wire Stripper & Cutter Model 8

De luxe version of Model 3, incorporating a unique 8 gauge selector. Plastic covered handles. Price 9/6d.



Tape Head Maintenance Kit Size E

Specially designed to maintain the tape heads and other parts of the tape recorder in clean condition. Suitable for reel to reel or cassette tape recorders. Contents: Bottle Bib Instrument Cleaner. Two blue Tape Head Applicator tools. Two white Tape Head polisher tools. 10 applicator and polisher sticks. Double-ended brush. Packet cleaning tissues. Instruction leaflet; all in a Folding Plastic Wallet. Price 16/6d. inc. P.T. Applicator and polisher tools and sticks are available separately.

Professional Tape Head Maintenance Kit Size K

For Service Organisations, Recording and Broadcasting Studios. Contains bulk quantities of items listed under Size E. Price £3.8.5. inc. P.T.



Ersin Multicore Solder Size 17

Contains 30 ft. of 40/60 Alloy, 15 s.w.g. wound on a handy spool. Suitable for all general Electrical repairs. Price 5/-

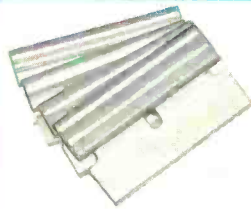

Precision Tape Cutters Size M

Set of four stainless steel cutters, with special plastic grip, for all types of magnetic recording tape. Price 2/10d. inc. P.T.



Savbit Solder Dispenser Size 5

Contains 10' of 18 s.w.g. Ersin Multicore Savbit Alloy. Price 2/6d.

Fine Gauge Solder Size 15

21 ft. coil of 60/40 Alloy, 22 s.w.g. Ersin Multicore Solder in a dispenser. Ideal for small components, transistors, diodes, etc. Price 3/-.



Recording Tape Splicer Model 20

For quick and accurate editing. Precision made, chrome plated clamps, mounted on non-slip base. Complete with razor cutter. Price 19/6d.

Instrument Cleaner Size A

Anti-static, specially formulated for cleaning delicate instrument panels, plastic, chrome, glass and printed surfaces. Non-flammable, does not smear. 4 fl. oz. in plastic bottle. Price 4/6d.



Ersin Multicore 5 Core Solder Size 12

For Service Engineers and Laboratories. Contains 90 ft. of 18 s.w.g. Ersin Multicore Savbit Alloy on a plastic reel. Price 15/-.



1/2" Video Tape Splicer Kit Model 21

Suitable for editing video tapes made on Sony Recorders. Fitted with tape clamps. Complete with a packet of Size M cutters, Size E kit and Size L Hi Fusters in plastic box. Price £9.10.0.



Cable & Flex Shortener

Shortens audio cables and flexes without cutting. Pack of 4 plastic shorteners. Price 2/6d.

All prices recommended retail U.K. only. Obtainable from leading electrical and audio shops. If in difficulty, write to:

**BIB DIVISION
MULTICORE SOLDERS LTD.**

Hemel Hempstead, Herts. Tel: Hemel Hempstead 3636 Telex: 82363

